

# PT Medium voltage fuses for potential and small power transformers



**Description:**

Bussmann™ series indicating and non-indicating E-Rated, current-limiting, medium voltage fuses for potential, small power and control transformers.

**Contents**

Description	Page
Introduction . . . . .	2
2.475 kV fuses . . . . .	3-6
3.6 kV fuses . . . . .	7-9
5.5 kV fuses . . . . .	10-26
7.2 kV fuses . . . . .	27-29
8.3 kV fuses . . . . .	30-39
12 kV fuses . . . . .	40-42
15.5 kV fuses . . . . .	43-52
17.5 kV fuses . . . . .	53-54
24 kV fuses . . . . .	55-56
25.5 kV fuses . . . . .	57-60
36 kV fuses . . . . .	61-62
38 kV fuses . . . . .	63-69
Fuse mountings . . . . .	70-71

**Features and benefits**

- Low amp, current-limiting E-Rated PT medium voltage fuses are general purpose fuses defined by their melting time-current characteristic that permit their electrical interchangeability with other fuses of the same E Rating.
- E-Rated general purpose fuses must have a current responsive element that will melt in 300 seconds at an RMS current within the range of 200% to 240% of the fuse’s nameplate current rating, fuse refill, or link per ANSI C37.46 for fuses rated 100E or less.
- PT fuses are physically dimensioned for easy installation in existing hardware.
- Space saving size eases design considerations for new installations.
- Current-limiting fuses provide positive interruption even on low fault currents. The fuse limits the magnitude of electromechanical stresses in the protected apparatus.
- These fuses are in a self-contained, non-venting package for installation indoors or outdoors in an enclosure.
- Available in indicating and non-indicating versions.
- Open fuse indicator speeds troubleshooting by providing a positive visual indication of fuse operation.

**Typical applications**

- Primary protection of:
  - Medium voltage potential transformers
  - Small medium voltage service transformers
  - Small medium voltage control transformers.

## E-Rated PT medium voltage fuses

### Catalog symbols (by maximum voltage rating):

- 2.475 kV
  - 2NCLPT\_
- 3.6 kV
  - 3.6ABCNA\_
  - 3.6ABWNA\_
  - 3.6CAV\_
- 5.5 kV
  - JCW\_
  - 5CLPT\_E
  - 5NCLPT\_E
  - 5NCLPT\_E-A
  - 5.5ABWNA\_E
  - 5.5AMWNA\_E
  - 5.5CAV\_E
  - 5.5CAVH\_E
- 7.2 kV
  - 7.2ABWNA\_
  - 7.2ABCNA\_
  - 7.2AMWNA\_E
  - 7.2CAV\_
- 8.3 kV
  - 8CLPT\_E-A
  - 8CLPT\_E-B
  - 8NCLPT\_E
  - 8NCLPT\_E-A
  - 8NCLPT\_E-B
- 12kV
  - 12ABCNA\_
  - 12CAV\_
- 15.5 kV
  - 15CLPT\_E
  - 15NCLPT\_E-A
  - 15.5CAV\_E
  - 15.5CAVH\_E
- 17.5 kV
  - 17.5ABGNA\_
  - 17.5CAV\_
- 24 kV
  - 24ABGNA\_
  - 24CAV\_

- 25.5 kV
  - 25CLPT\_E
- 36 kV
  - 36ABGNA\_
  - 36CAV\_
- 38 kV
  - 38CAV\_E
  - 38CAVH\_E
  - 38CLPT\_E

### Ratings\*:

- Volts
  - 2.4 kV to 38 kV
- Amps
  - 0.25 to 15 A
- Interrupting ratings
  - 25 to 80 kA RMS Sym

\* See catalog number tables for voltages, ampacities and interrupting ratings by catalog number.

### Agency information:

- Those PT fuses conforming to the requirements for E-Rating meet the performance characteristics of IEEE/ANSI C37.46

2.475 kV maximum system voltage

Amp rating	Dimensions - in (mm)			Catalog No. (Interrupting rating - kA)		Recommended fuseclip
	Length A	Diameter B	Clip centers C	Indicating	Non-indicating	
0.25				—	2NCLPT-.25E (63)	
0.5				—	2NCLPT-.5E (63)	
1	4.5 (114)	0.8 (20)	3.9 (99)	—	2NCLPT-1E (40)	1A1837
2				—	2NCLPT-2E (40)	
5				—	2NCLPT-5E (25)	

Dimensions (see catalog number tables for values)

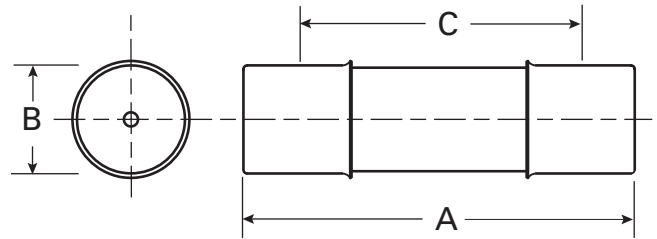

Recommended fuseclip and fuse block:

Description	Cat. No.
Open fuseclip for 0.8 (20mm) dia. fuses	1A1837
Single-pole open fuse block with #10-32 phil-slot screw terminals rated 2500V, 5A maximum and 63kA withstand rating	PTFB-2500-JCD

2.47 kV time-current curves — minimum melting for 2NCLPT-E

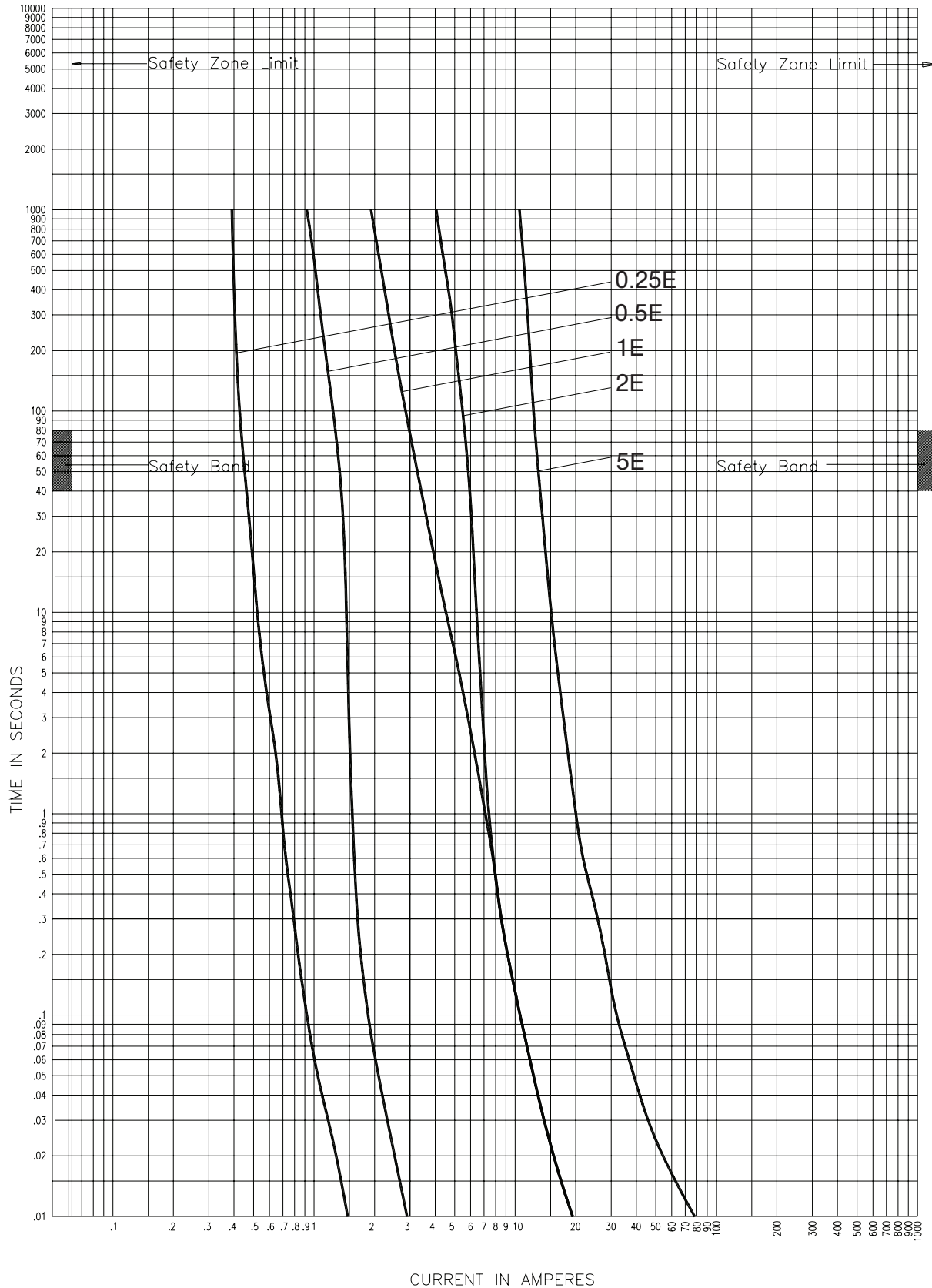

2NCLPT-E

Curve TC56357202  
December 2008



2.47 kV time-current curves — total clearing for 2NCLPT\_E

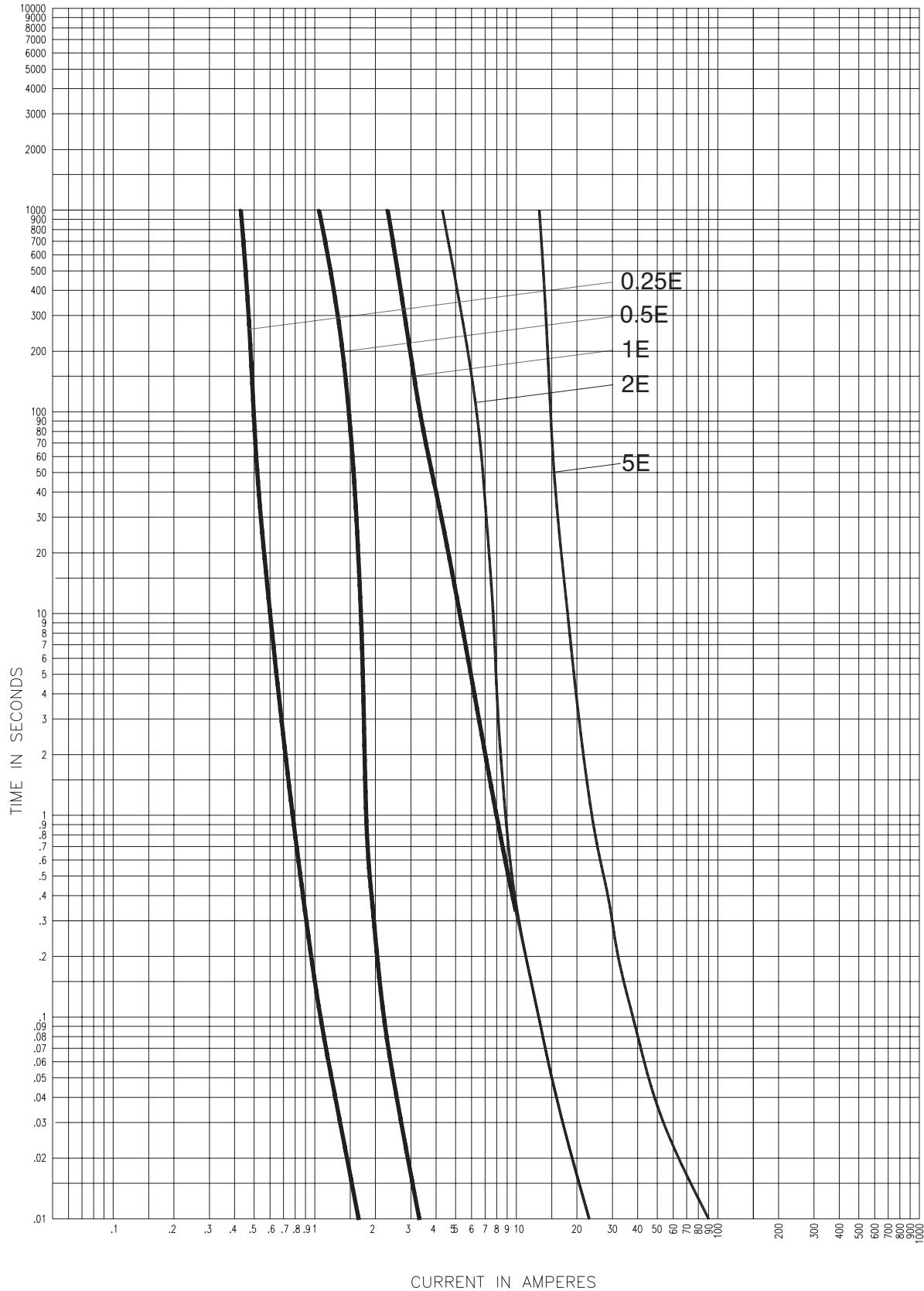

2NCLPT\_E

Curve TC59883702  
October 2010

2.47 kV peak let-through curves for 2NCLPT\_E

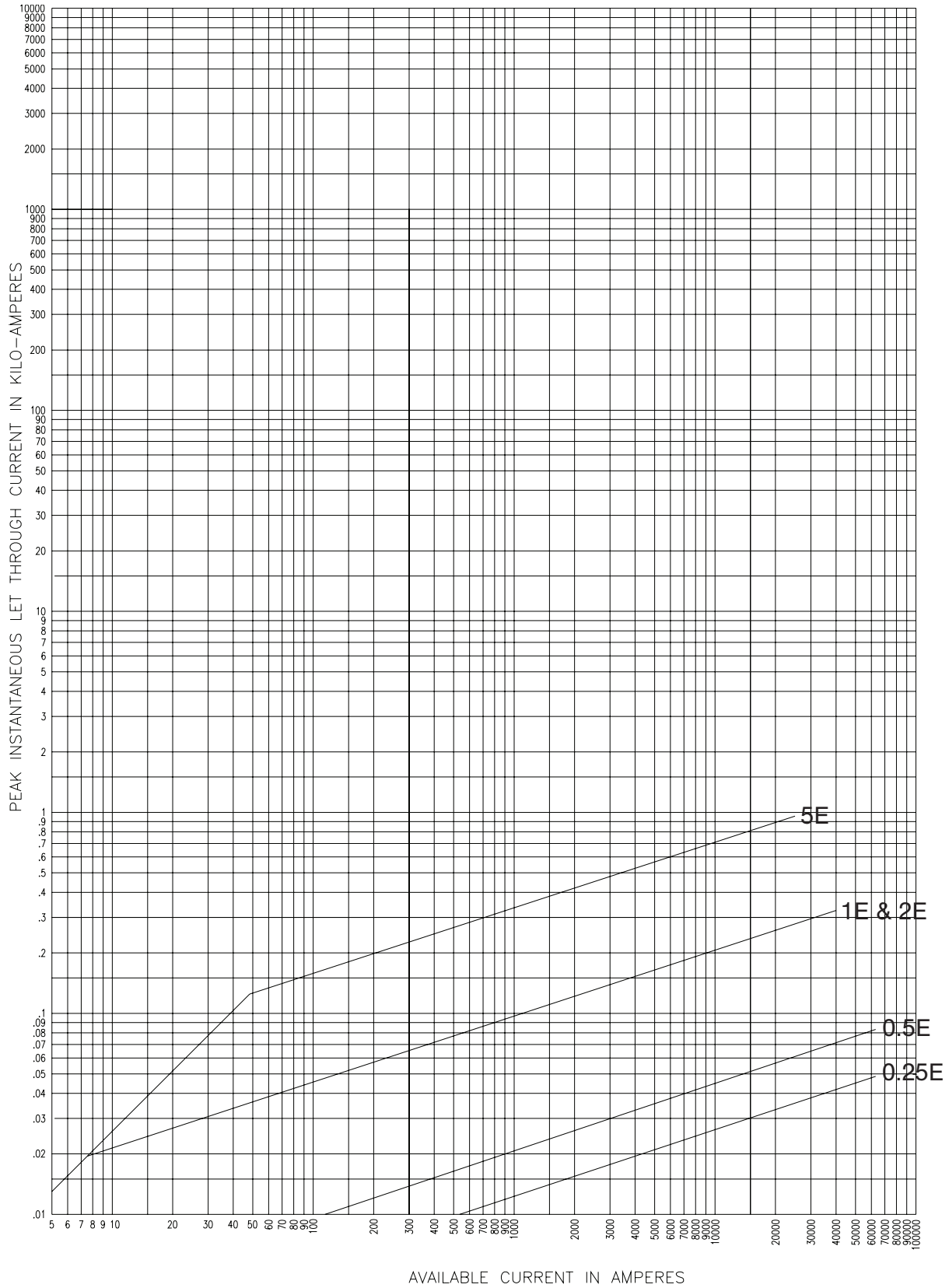

2NCLPT\_E

Curve TC63933702  
December 2008

3.6 kV maximum system voltage

Amp rating	Dimensions - in (mm)			Catalog No. (Interrupting rating - kA)		
	Length A	Diameter B	Clip centers C	Indicating	Non-indicating	Recommended fuseclip
2	8.7 (221)	1.6 (41)	7.6 (193)	—	3.6CAV2 (50)	1A1837
3.15	5.6 (142)	1 (25)	4.4 (112)	—	3.6ABWNA3.15 (50)	
3.15	7.7 (195)	1 (25)	6.5 (165)	—	3.6ABCNA3.15 (50)	
6.3	5.6 (142)	1 (25)	4.4 (112)	—	3.6ABWNA6.3 (50)	A3354705
6.3	7.7 (195)	1 (25)	6.5 (165)	—	3.6ABCNA6.3 (50)	
10				—	3.6ABCNA10 (50)	

Dimensions (see catalog number tables for values)

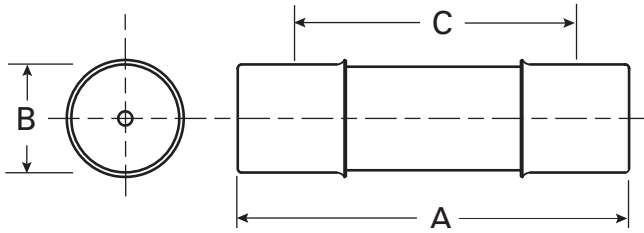

Recommended fuseclips:

Description	Cat. No.
Open fuseclip for 1.0 (25.4mm) dia. fuses	A3354705
Open fuseclip for 1.56 (39.7mm) / 1.6 (40.6mm) dia. fuses	1A0835

3.6 kV Time-current curves — minimum melting for 3.6CAV\_, 3.6ABC\_ and 3.6ABW\_

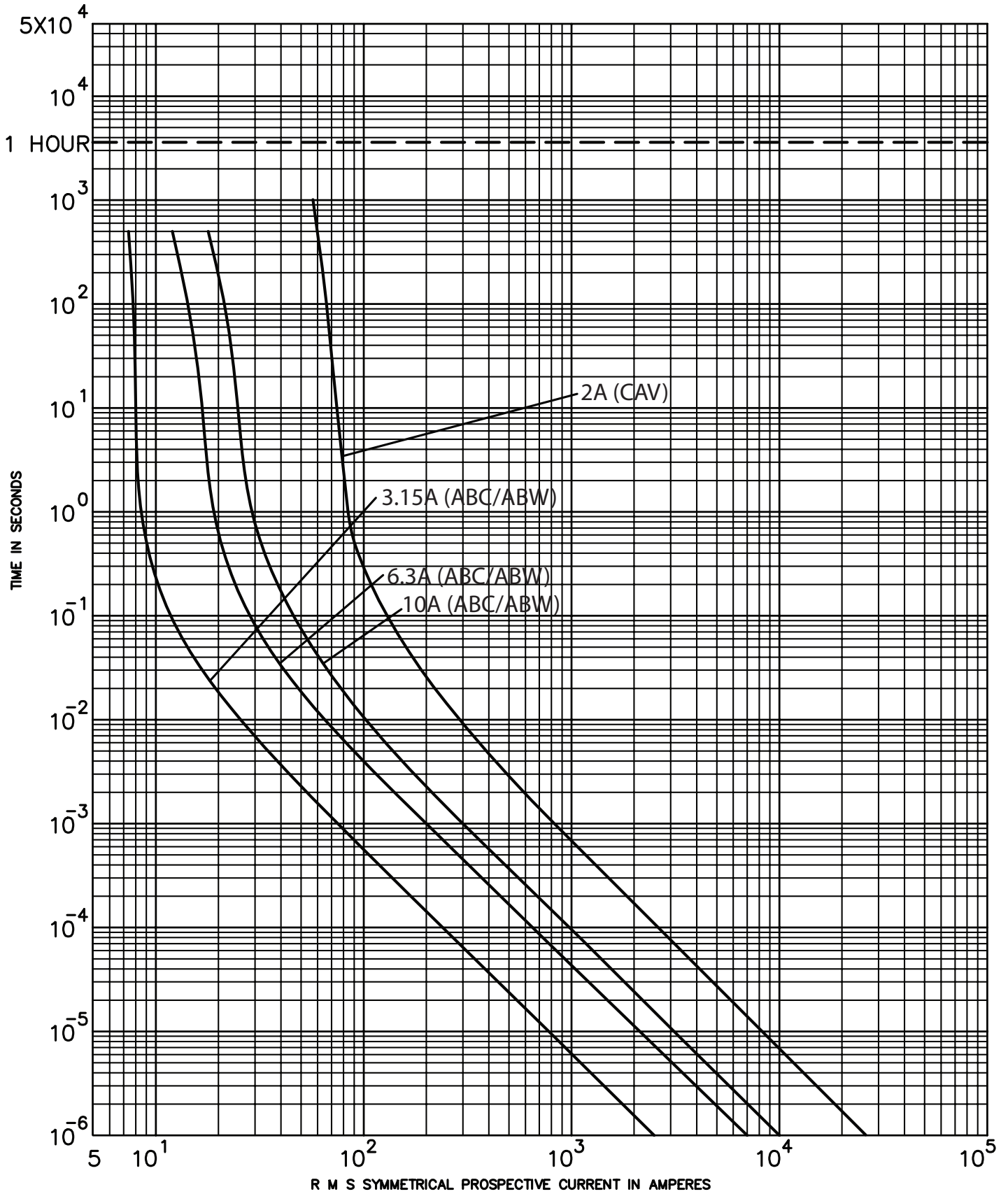

3.6ABC\_, 3.6ABW\_, 3.6CAV\_

3.6 kV Peak let-through curves for 3.6ABC\_ and 3.6ABW\_

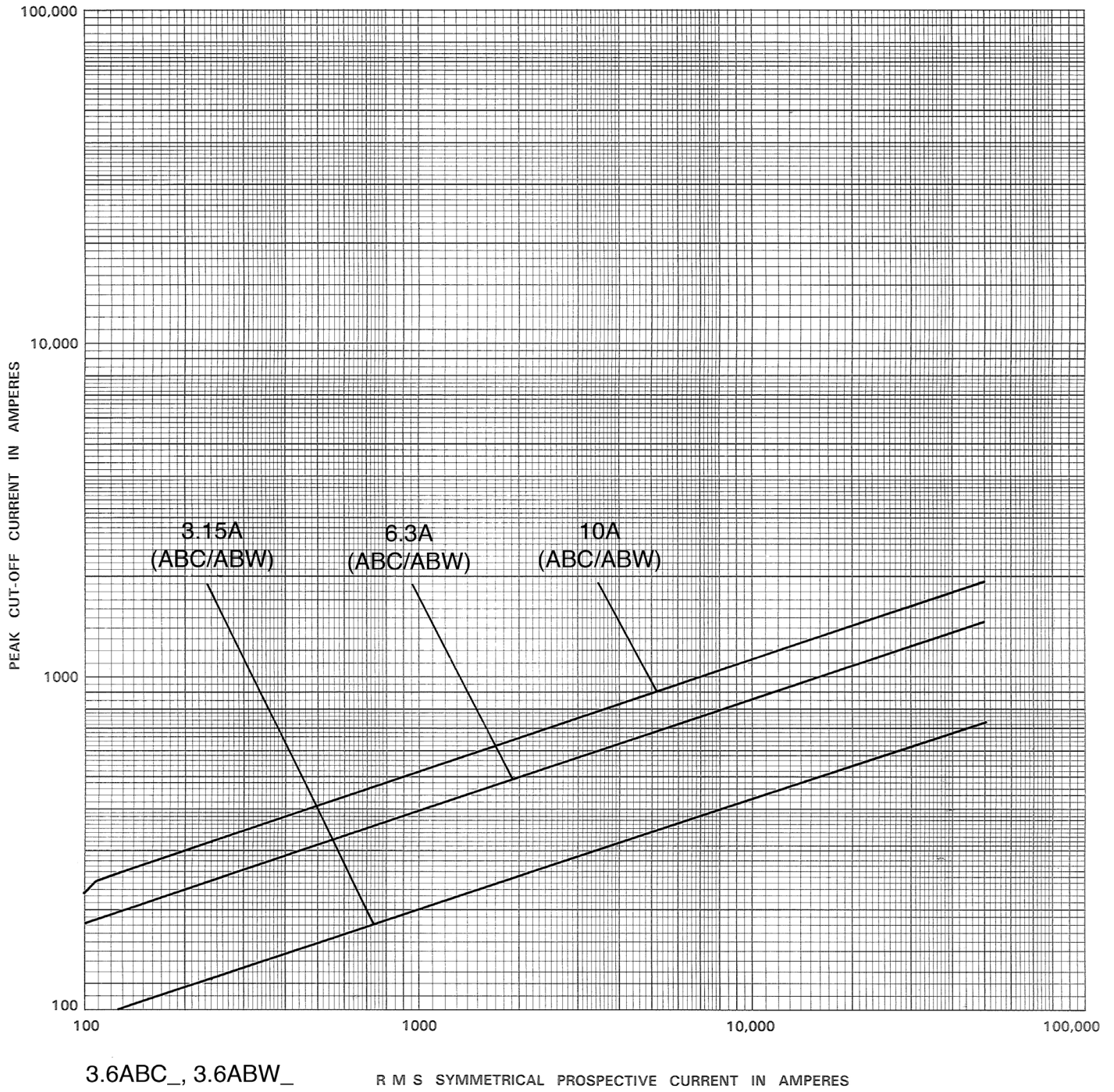

5.5 kV maximum system voltage

Amp rating	Dimensions - in (mm)			Catalog No. (Interrupting rating - kA)		Recommended fuseclip
	Length A	Diameter B	Clip centers C	Indicating	Non-indicating	
0.5	5.6 (142)	0.8 (20)	4.8 (122)	—	5.5AMWNA.5E (63)	1A1837
0.5	5.6 (142)	1 (25)	4.4 (112)	—	5.5ABWNA0.5E (50)	A3354705
0.5	7.4 (188)	1.6 (41)	6.2 (157)	5.5CAVH0.5E (50)	JCW-1/2E (40)	1A0835
0.5	9.5 (241)	1.6 (41)	8.1 (206)	5CLPT-5 (80)†	5NCLPT-5E-A (63)	
1	5.6 (142)	1 (25)	4.4 (112)	—	5.5ABWNA1E (50)	A3354705
1	5.6 (142)	0.8 (20)	4.8 (122)	—	5.5AMWNA1E (63)	1A1837
1	7.4 (188)	1.6 (41)	6.2 (157)	5.5CAVH1E (50)	JCW-1E (40)	1A0835
1	9.5 (241)	1.6 (41)	8.1 (206)	5CLPT-1 (80)†	5NCLPT-1E-A (63)	
1.5	9.5 (241)	1.6 (41)	8.1 (206)	5CLPT-1.5 (80)†	—	1A0835
2	5.6 (142)	1 (25)	4.4 (112)	—	5.5ABWNA2E (50)	A3354705
2	5.6 (142)	0.8 (20)	4.8 (122)	—	5.5AMWNA2E (63)	1A1837
2	7.4 (188)	1.6 (41)	6.2 (157)	5.5CAVH2E (50)	JCW-2E (40)	1A0835
2	9.5 (241)	1.6 (41)	8.1 (206)	—	5NCLPT-2E (63)	1A1837
3	5.6 (142)	1 (25)	4.4 (112)	—	5.5ABWNA3E (50)	A3354705
3	5.6 (142)	0.8 (20)	4.8 (122)	—	5.5AMWNA3E (63)	1A1837
3	9.5 (241)	1.6 (41)	8.1 (206)	5CLPT-3E (80)	5NCLPT-3E (63)	1A0835
3	7.4 (188)	1.6 (41)	6.2 (157)	—	JCW-3E (40)	1A0835
4	5.6 (142)	0.8 (20)	4.8 (122)	—	5.5AMWNA4E (63)	1A1837
5	9.5 (241)	1.6 (41)	8.1 (206)	5CLPT-5E (80)	5NCLPT-5E-A (63)	1A0835
5	5.6 (142)	1 (25)	4.4 (112)	—	5.5ABWNA5E (50)	A3354705
5	5.6 (142)	0.8 (20)	4.8 (122)	—	5.5AMWNA5E (63)	1A1837
5	7.3 (185)	1.6 (41)	5.9 (150)	—	JCW-5E (40)	1A0835
10	9.5 (241)	1.6 (41)	8.1 (206)	5CLPT-10E (80)	5NCLPT-10E-A (63)	1A0835
15	7.4 (188)	1.6 (41)	6.2 (157)	—	5.5CAV15E (50)	

† Due to manufacturing variances, this fuse does not comply with ANSI C37.46 for “E” rating. See time-current curves for performance characteristics.

CLPT Type mountings and hardware 5.5 kV maximum (4.8kV nominal)\*

Amp rating	Fuse mounting type**	BIL (kV)	Catalog number			
			Mounting (including live parts, end fittings)***		Live parts (including end fittings)***	End fittings (disconnect only)
			Porcelain insulator	Glass-polyester insulator		
<b>CLPT and NCLPT-A Mounting</b>						
0.5–10	Non-disconnect	60	5CLPT-PNM-A	5CLPT-GNM-A	CLPT-NL	—
	Disconnect†	60	5CLPT-PDM-A	5CLPT-GDM-A	CLPT-DL	CLPT-DF

\* Refers to 5CLPT and 5NCLPT fuses only.

\*\* See page 70 for dimensions and diagrams of typical mounting.

\*\*\* End fittings supplied only when required.

† Disconnect mountings provide a means for fuse extraction only. Do not use a disconnect mounting for load switching or fuse removal while energized.

**Dimensions (see catalog number tables for values)**

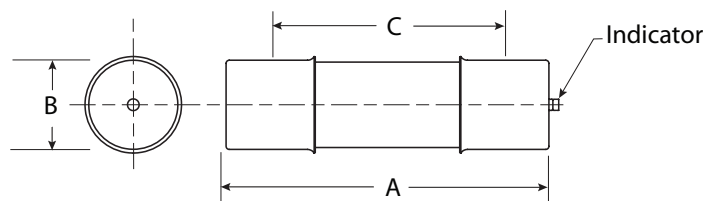

**Recommended fuseclips:**

Description	Cat. No.
Open fuseclip for 0.8 (20 mm) dia. fuses	1A1837
Open fuseclip for 1.0 (25.4 mm) dia. fuses	A3354705
Open fuseclip for 1.56 (39.7 mm) / 1.6 (40.6 mm) dia. fuses	1A0835

5.5 kV time-current curves — minimum melting for 5NCLPT\_-A

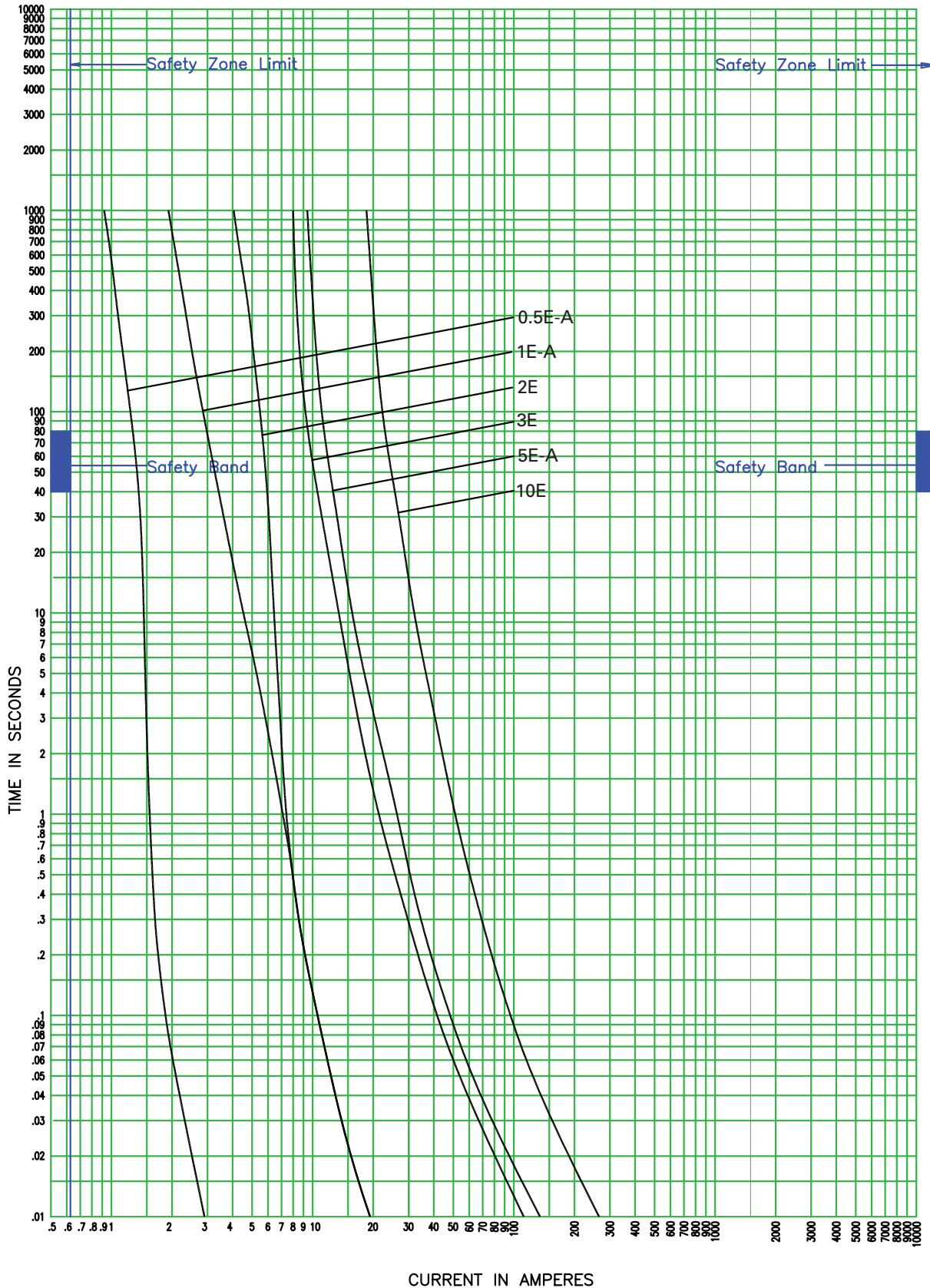

5NCLPT\_E

CURVE TC70548302  
December 2008



5.5 kV time-current curves — total clearing for 5NCLPT\_-A

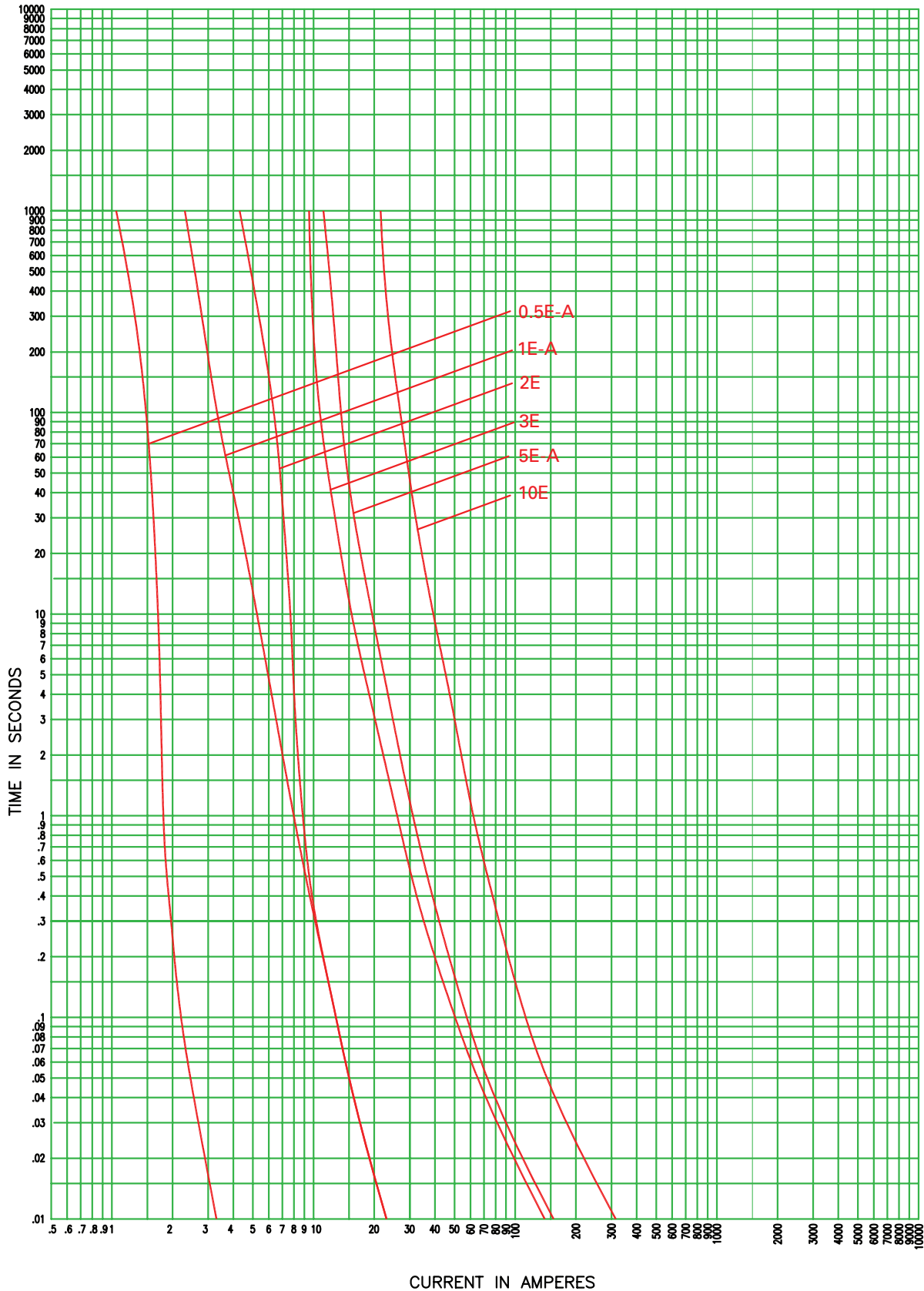

5NCLPT\_E

CURVE TC70548402  
December 2008

5.5 kV peak let-through curves for 5NCLPT\_-A

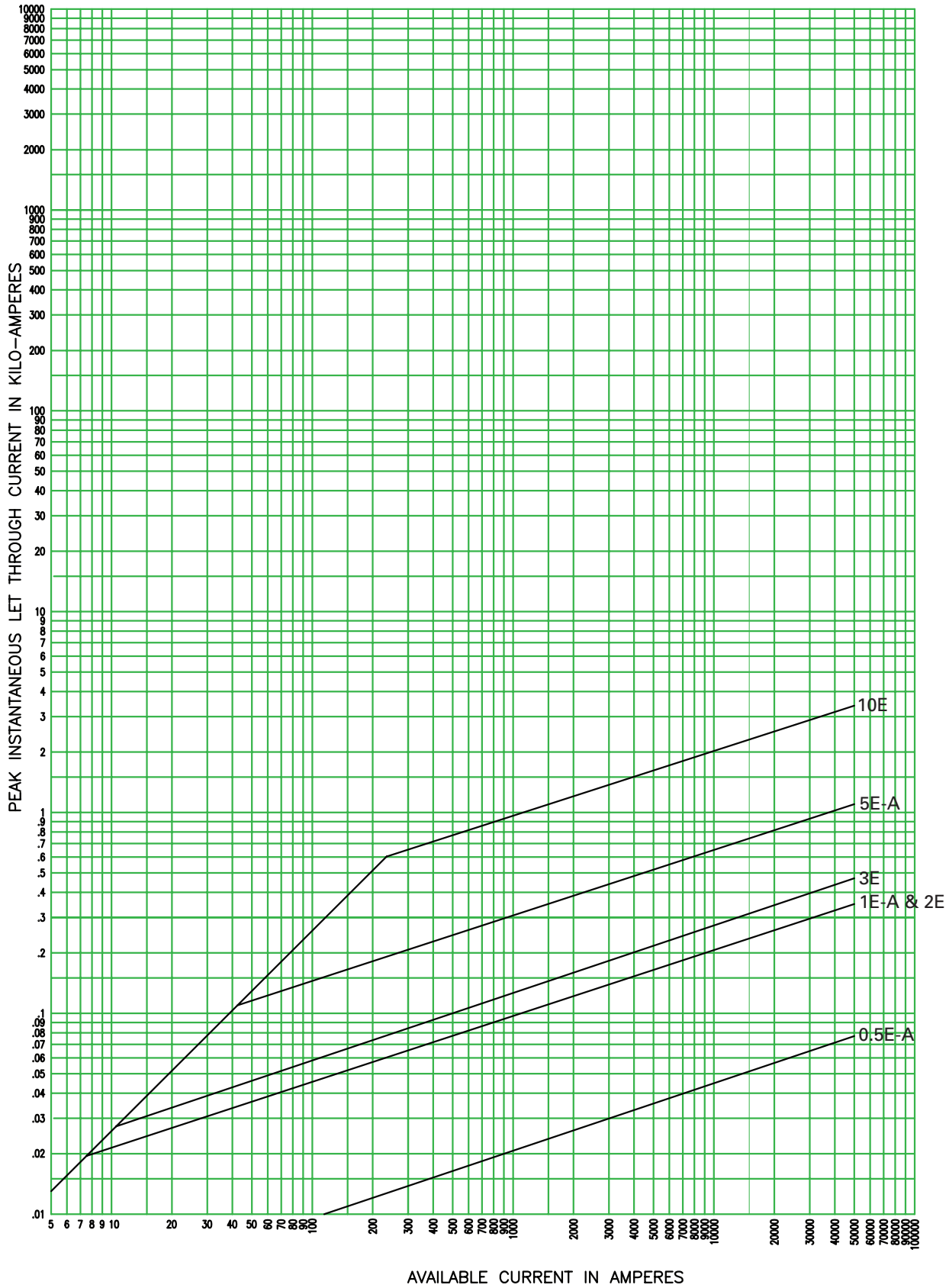

5NCLPT- E

CURVE TC63934002  
December 2008

5.5 kV Time-current curves — total clearing for 5CLPT\_

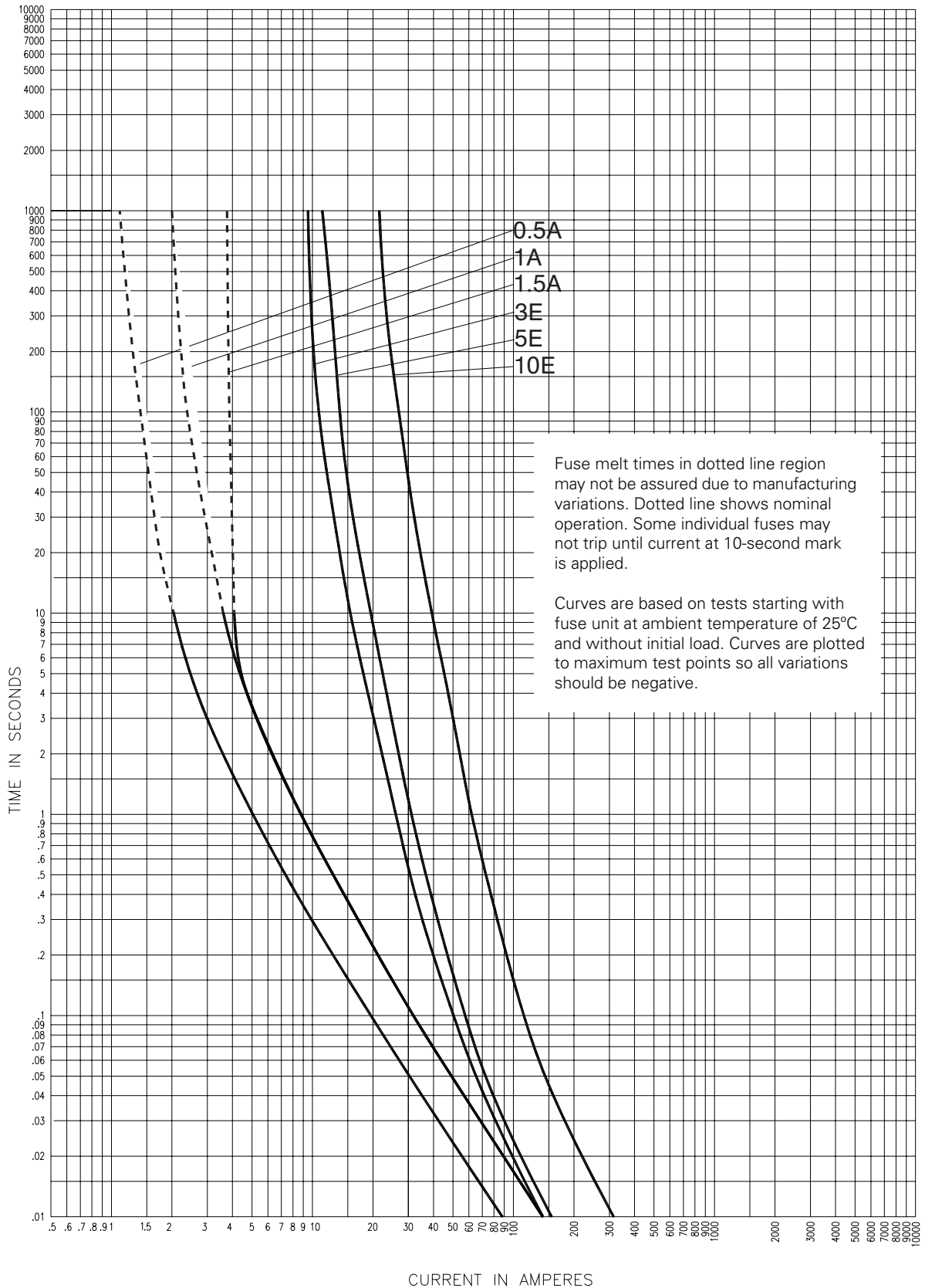

5CLPT\_

Curve TC56353306  
August 2011

5.5 kV peak let-through curves for 5CLPT\_

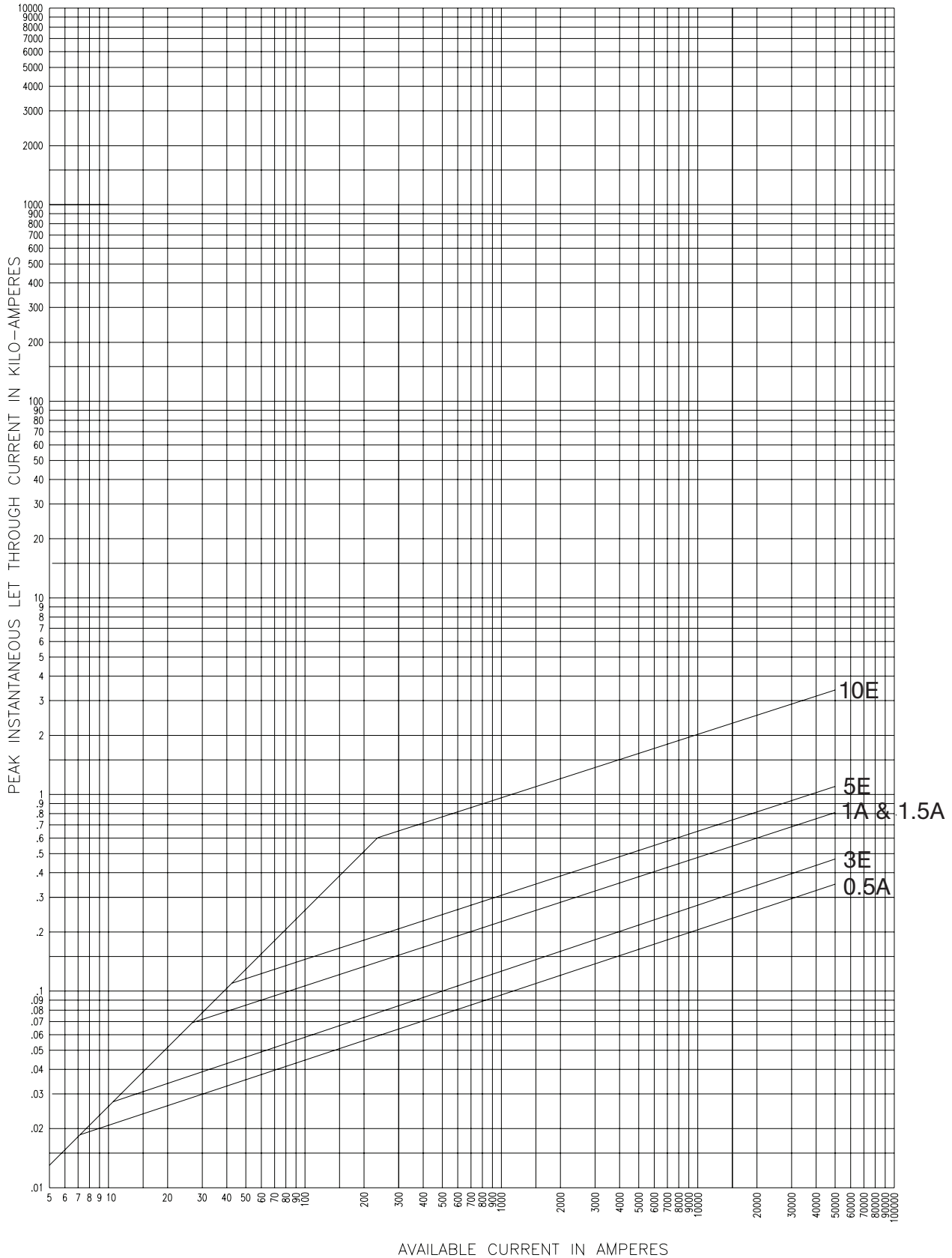

5CLPT\_

Curve TC63934001  
March 2013

5.5 kV time-current curves — minimum melting for 5.5CAV\_ and 5.5CAVH\_

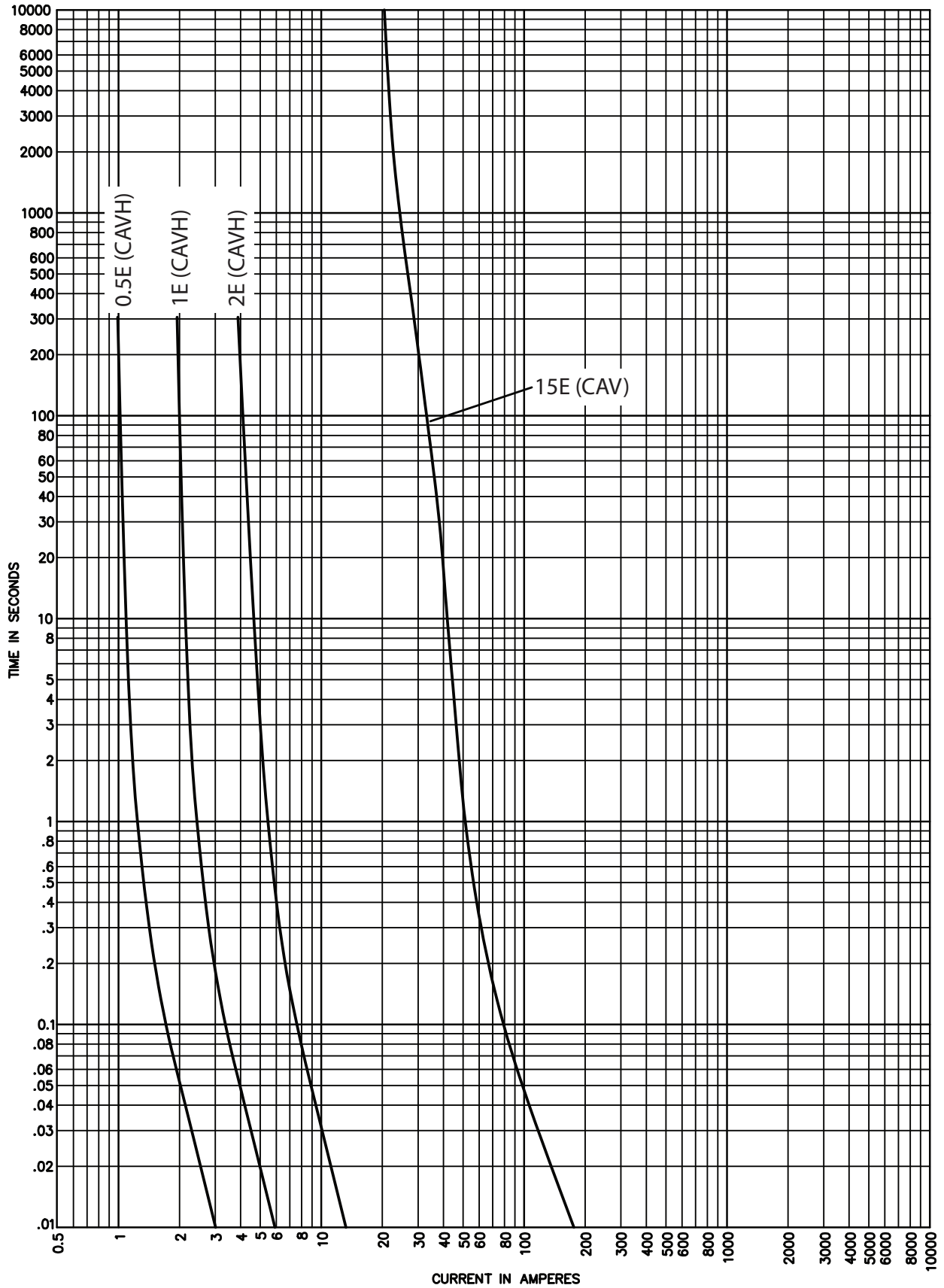

5.5CAV\_, 5.5CAVH\_

5.5 kV time-current curves — total clearing for 5.5CAV<sub>1</sub>

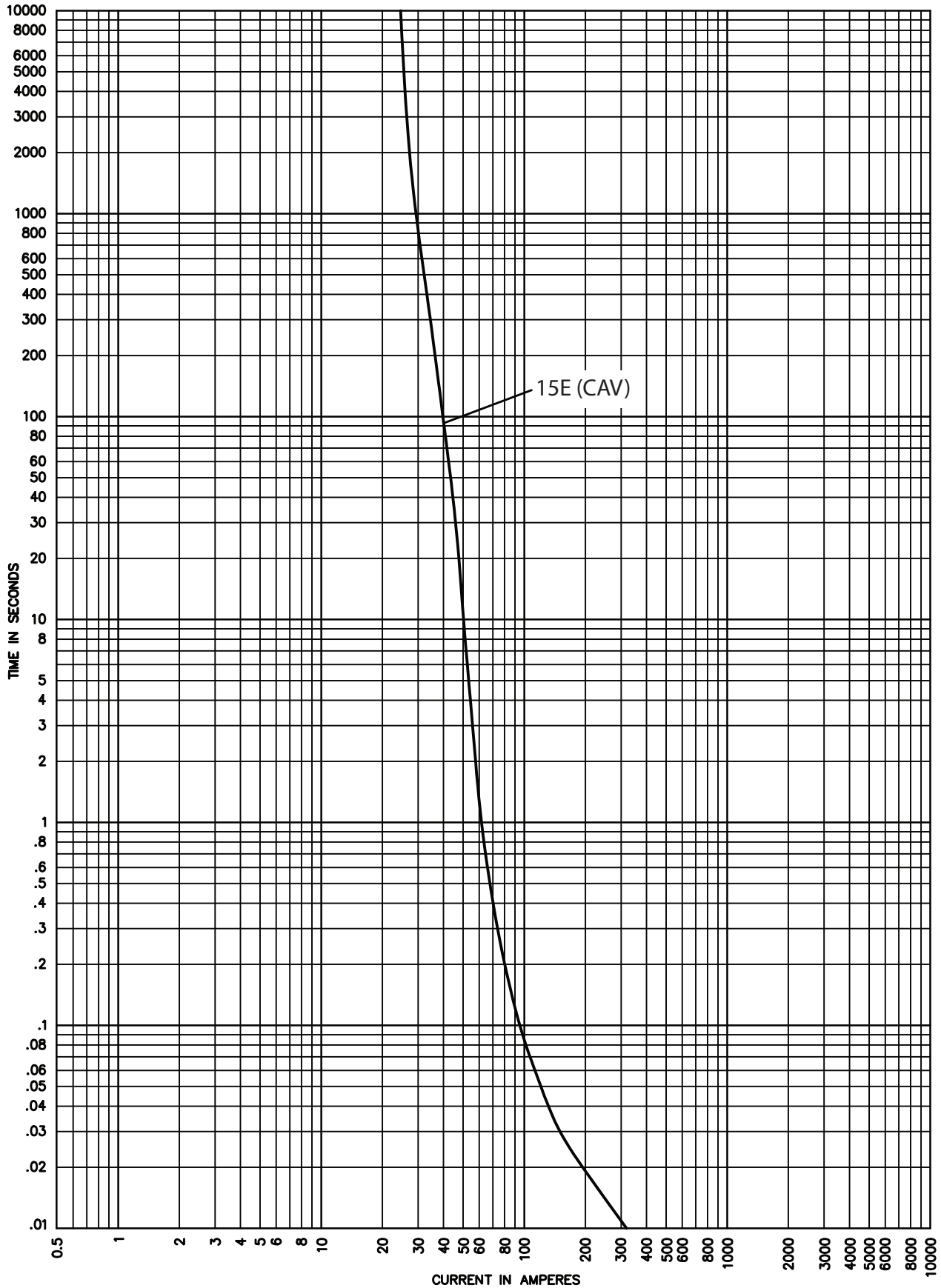

5.5CAV

5.5 kV peak let-through curves for 5.5CAVH\_

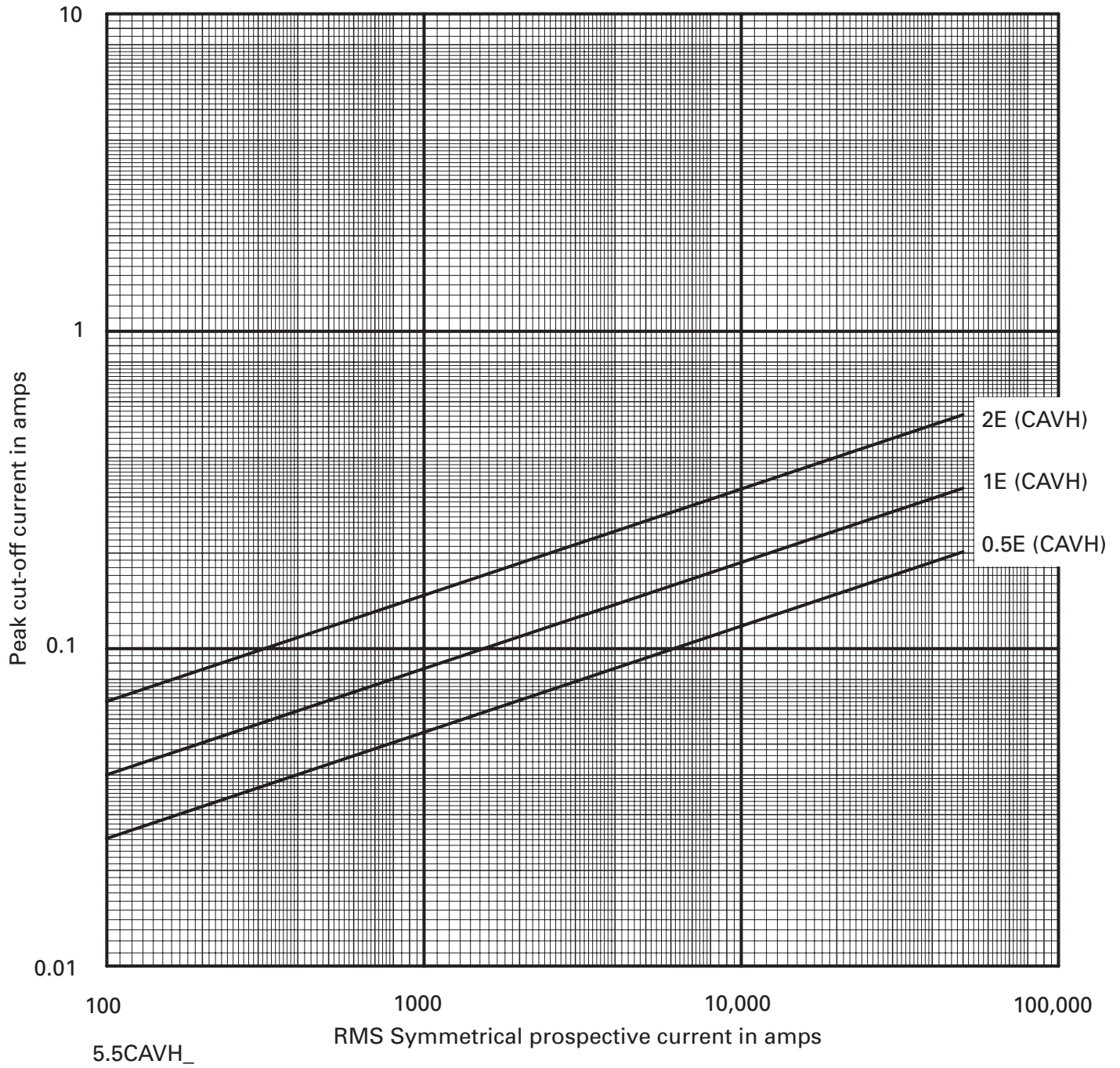

5.5 kV time-current curves — minimum melting for 5.5ABW\_ and 5.5AMW\_

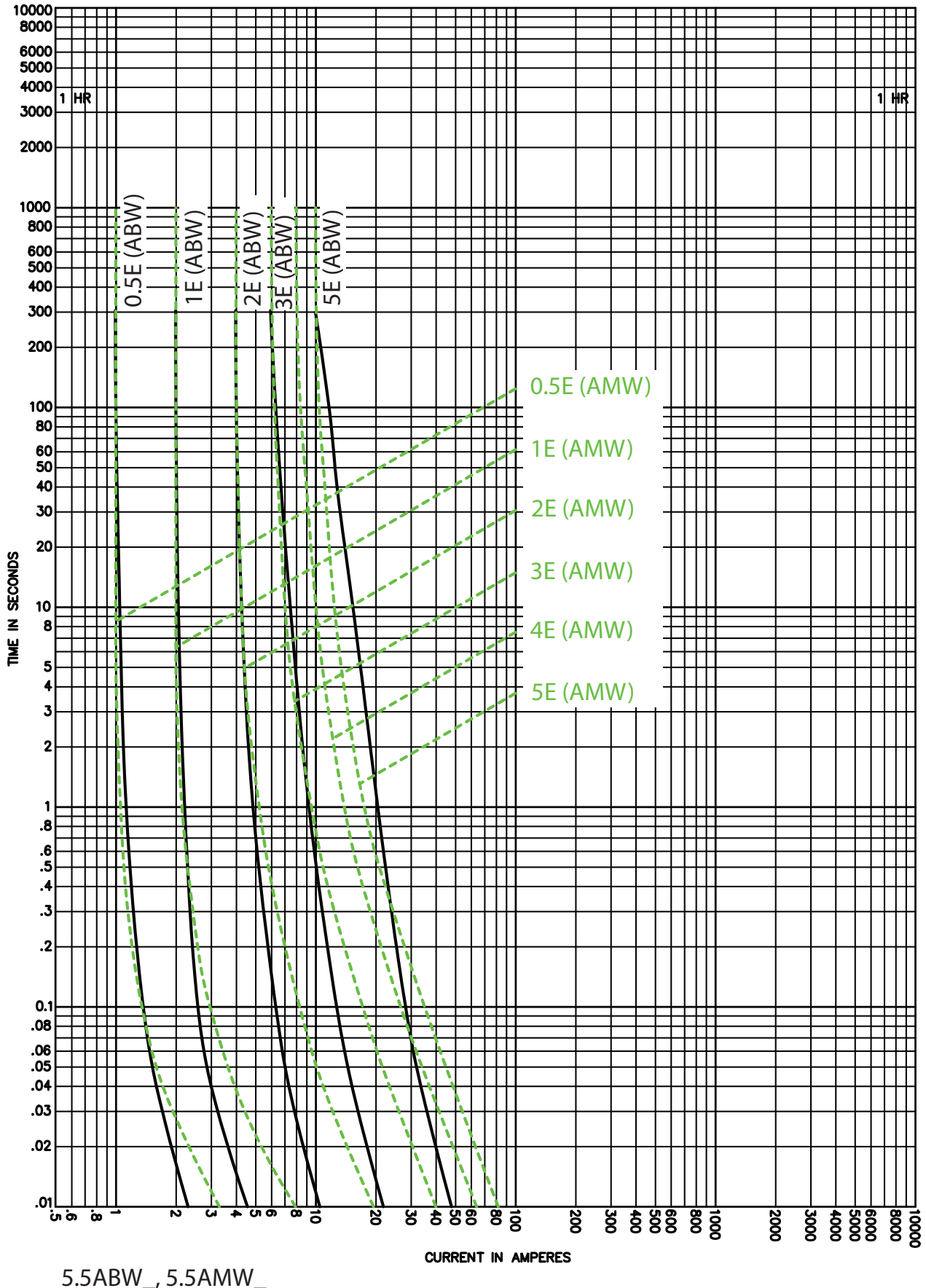

5.5ABW\_ , 5.5AMW\_



5.5 kV time-current curves — total clearing for 5.5ABW\_ and 5.5AMW\_

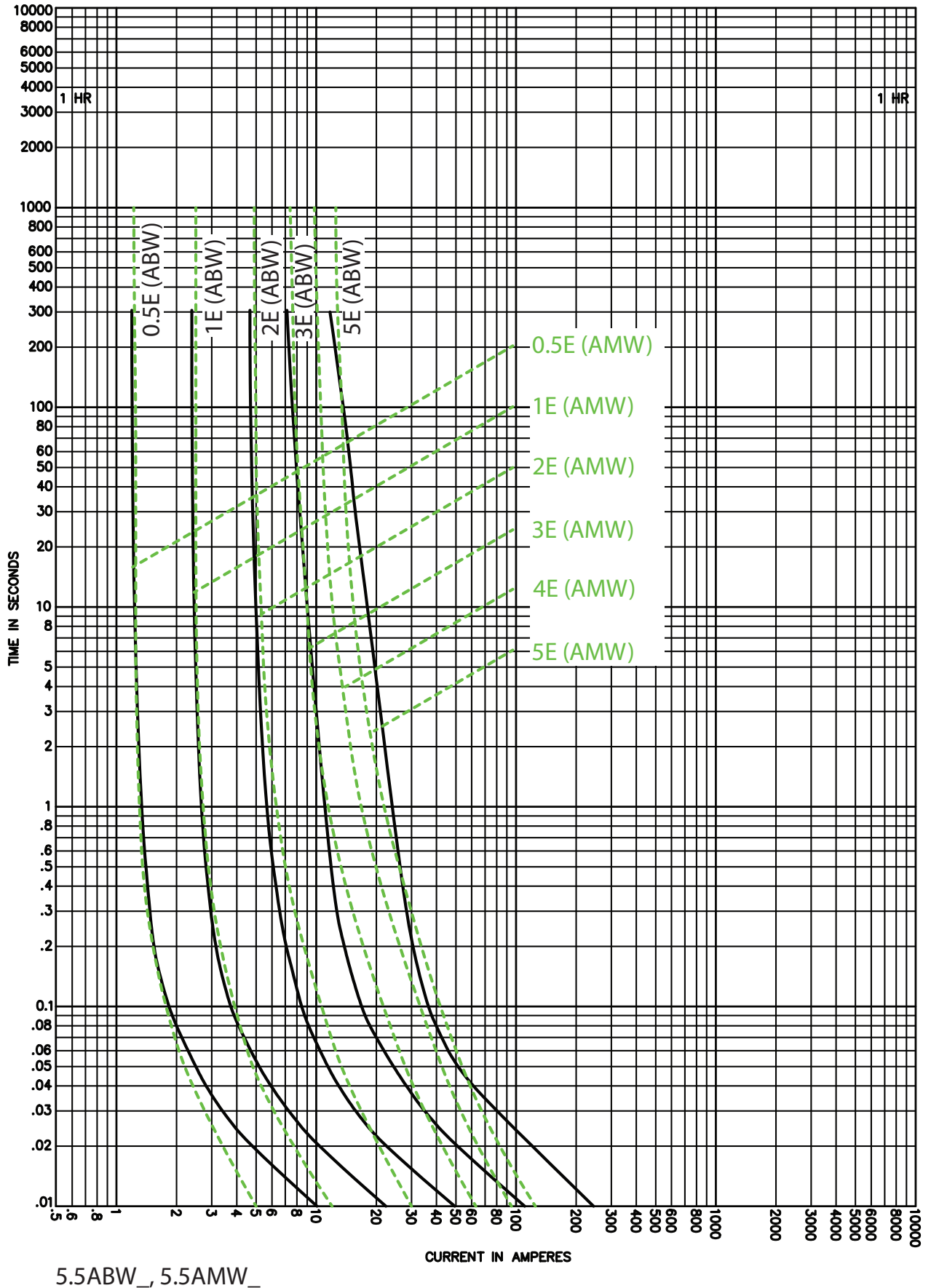

5.5ABW\_ , 5.5AMW\_

5.5 kV peak let-through curves for 5.5ABW\_ and 5.5AMW\_

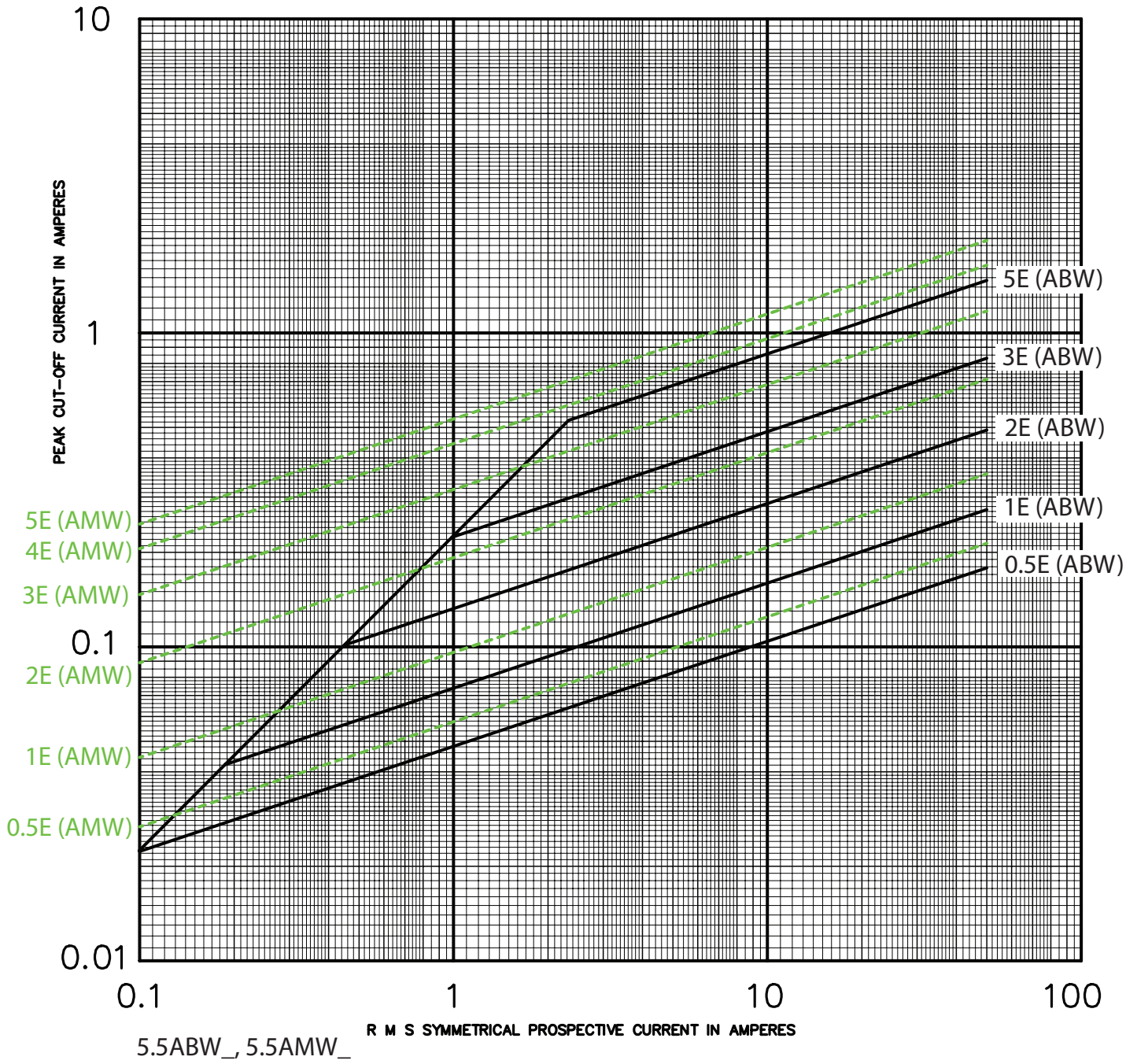

7.2 kV maximum system voltage

Amp rating	Dimensions - in (mm)			Catalog No. (Interrupting rating - kA)		Recommended fuseclip
	Length A	Diameter B	Clip centers C	Indicating	Non-indicating	
0.5	5.6 (142)	0.8 (20)	4.8 (122)	—	7.2AMWNA0.5E (50)	
1	5.6 (142)	0.8 (20)	4.8 (122)	—	7.2AMWNA1.0E (50)	1A1837
2	5.6 (142)	0.8 (20)	4.8 (122)	—	7.2AMWNA2.0E (50)	
2	8.7 (221)	1.6 (41)	7.5 (190)	—	7.2CAV2 (40)	1A0835
3	5.6 (142)	0.8 (20)	4.8 (122)	—	7.2AMWNA3.0E (50)	1A1837
3.15	5.6 (142)	1 (25.4)	4.4 (112)	—	7.2ABWNA3.15 (45)	
3.15	7.7 (195)	1 (25.4)	6.5 (165)	—	7.2ABCNA3.15 (45)	A3354705
4	5.6 (142)	0.8 (20)	4.8 (122)	—	7.2AMWNA4.0E (50)	1A1837
4	8.7 (221)	1.6 (41)	7.5 (190)	—	7.2CAV4 (40)	1A0835
5	5.6 (142)	0.8 (20)	4.8 (122)	—	7.2AMWNA5E (50)	1A1837
6	8.7 (221)	1.6 (41)	7.5 (190)	—	7.2CAV6 (40)	1A0835
6.3	5.6 (142)	1 (25.4)	4.4 (112)	—	7.2ABWNA6.3 (45)	
6.3	7.7 (195)	1 (25.4)	6.5 (165)	—	7.2ABCNA6.3 (45)	A3354705
10	8.7 (221)	1.6 (41)	7.5 (190)	—	7.2CAV10 (40)	1A0835

Dimensions (see catalog number tables for values)

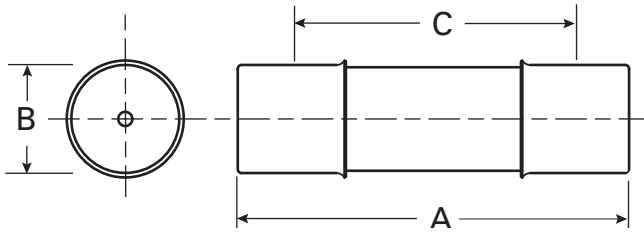

Recommended fuseclips

Description	Cat. No.
Open fuseclip for 0.8 (20 mm) dia. fuses	1A1837
Open fuseclip for 1.0 (25.4 mm) dia. fuses	A3354705
Open fuseclip for 1.56 (39.7 mm) / 1.6 (40.6 mm) dia. fuses	1A0835

7.2 kV time-current curves — minimum melting for 7.2ABW\_ and 7.2CAV\_

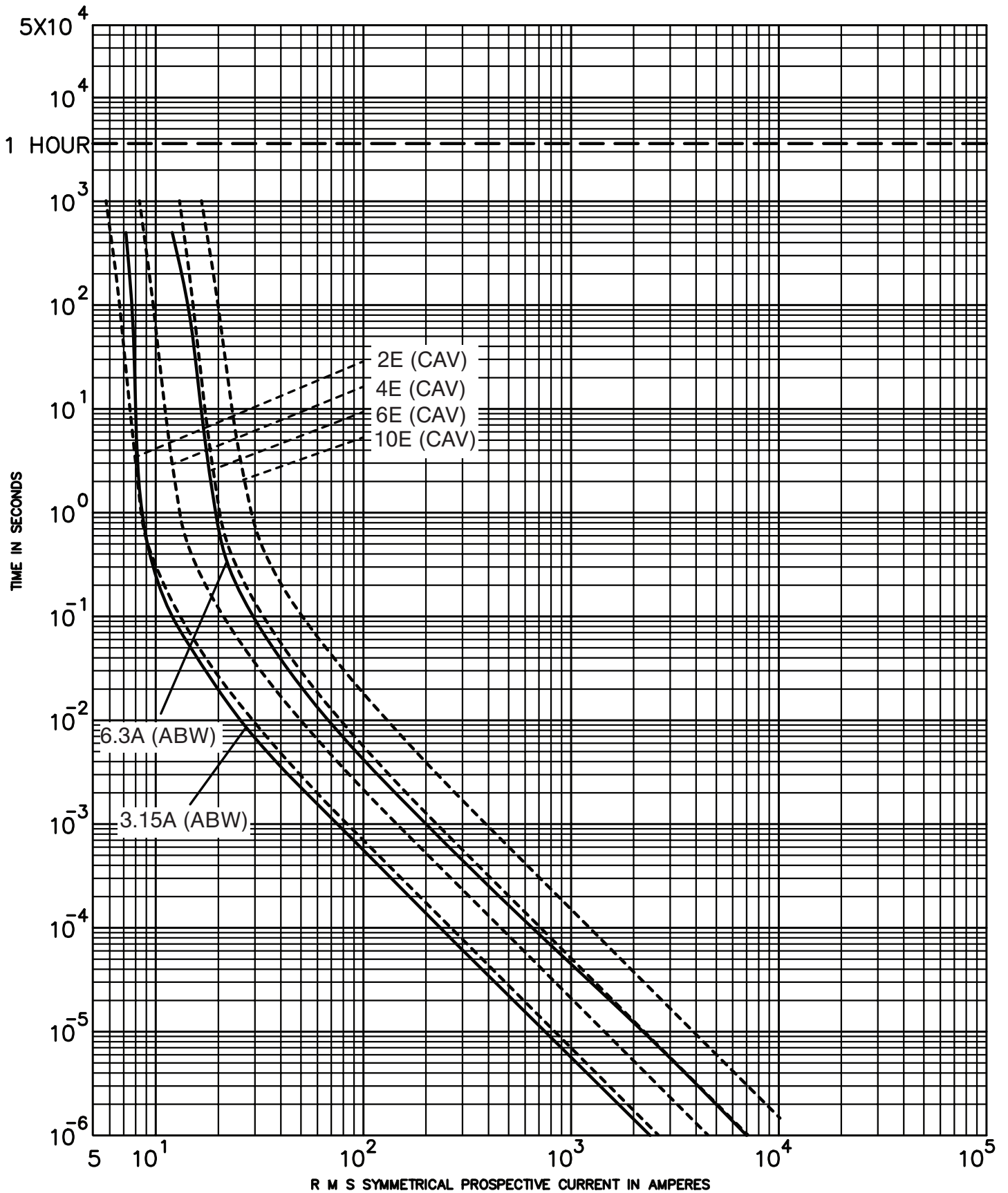

7.2ABW\_ , 7.2CAV\_

7.2 kV peak let-through curves for 7.2ABW\_

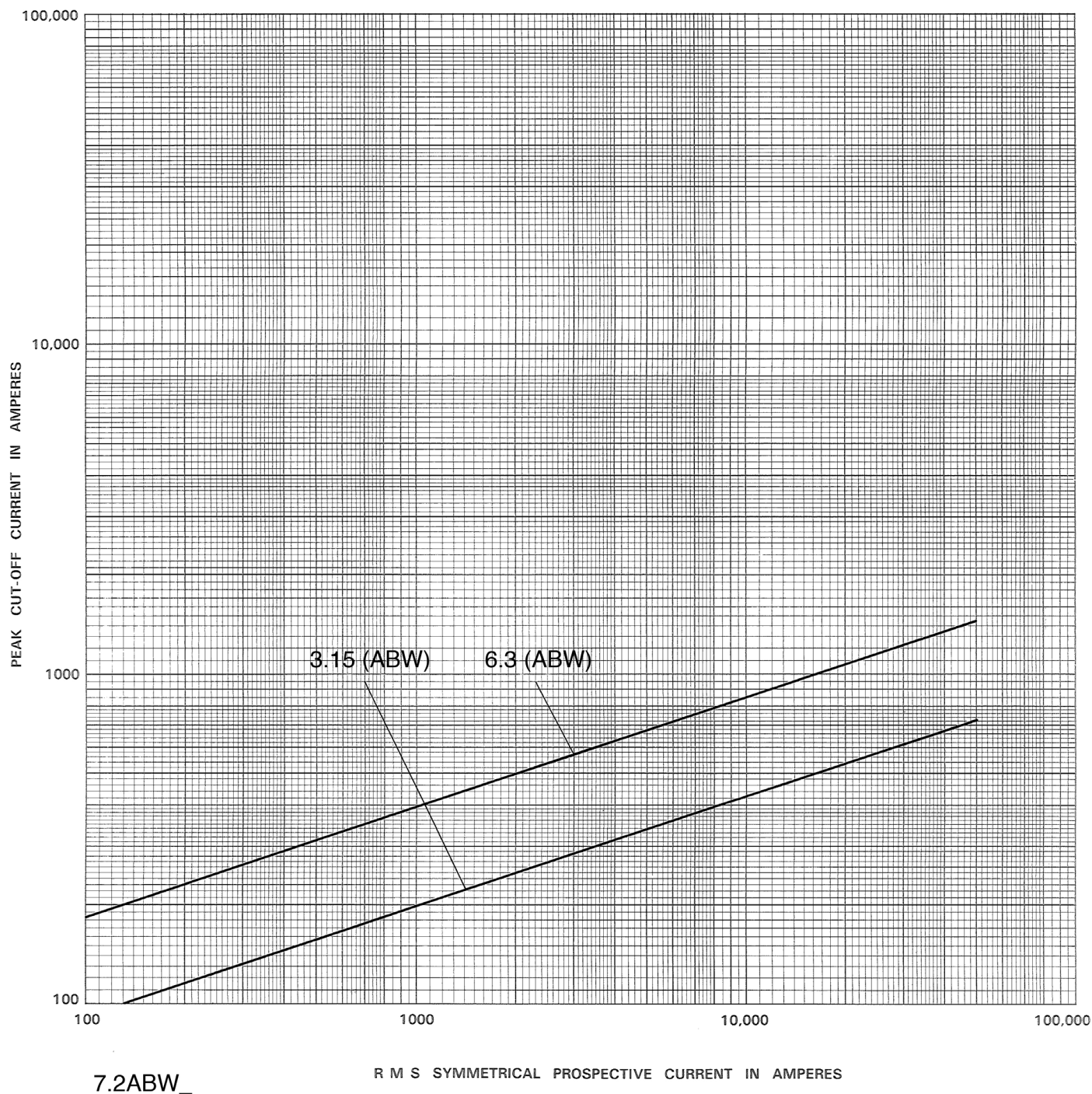

7.2ABW\_

R M S SYMMETRICAL PROSPECTIVE CURRENT IN AMPERES

8.3 kV maximum system voltage

Amp rating	Dimensions - in (mm)			Catalog No. (interrupting rating - kA)		Recommended fuseclip
	Length A	Diameter B	Clip centers C	Indicating	Non-indicating	
0.5	9.5 (241)	1.6 (41)	8.1 (206)	8CLPT-5 (50) <sup>†</sup>	8NCLPT-5E-A (50)	1A0835
1	5 (127)	1.1 (28)	4 (102)	—	8NCLPT-1E (50)	A3354705
1	9.5 (241)	1.6 (41)	8.1 (206)	—	8NCLPT-1E-A (50)	1A0835
2	8 (203)	0.8 (20)	7.2 (183)	—	8NCLPT-2E (25)	1A1837
2	9.5 (241)	1.6 (41)	8.1 (206)	—	8NCLPT-2E-A (50)	1A0835
3	12.9 (328)	1.6 (41)	11.5 (292)	8CLPT-3E (50)	8NCLPT-3E-B (50)	
4	8 (203)	0.8 (20)	7.2 (183)	—	8NCLPT-4E (25)	1A1837
5	5 (127)	1.1 (28)	4 (102)	—	8NCLPT-5E (50)	A3354705
5	12.9 (328)	1.6 (41)	11.5 (292)	8CLPT-5E (50)	8NCLPT-5E-B (50)	
8	5 (127)	1.1 (28)	4 (102)	—	8NCLPT-8E (50)	1A0835
10	12.9 (328)	1.6 (41)	11.5 (292)	8CLPT-10E (50)	8NCLPT-10E-B (50)	

<sup>†</sup> Does not comply with ANSI C37.46 for “E” rating.

CLPT type mountings and hardware 8.3 kV maximum (7.2 kV nominal)\*

Amp rating	Fuse mounting type**	BIL (kV)	Catalog number			
			Mounting (including live parts, end fittings)***		Live parts (including end fittings)***	End fittings (disconnect only)
			Porcelain insulator	Glass-polyester insulator		
0.5–2	Non-disconnect	75	8CLPT-PNM-A	8CLPT-GNM-A	CLPT-NL	—
	Disconnect <sup>†</sup>	75	8CLPT-PDM-A	8CLPT-GDM-A	CLPT-DL	CLPT-DF
3–10	Non-disconnect	75	8CLPT-PNM-B	8CLPT-GNM-B	CLPT-NL	—
	Disconnect <sup>†</sup>	75	8CLPT-PDM-B	8CLPT-GDM-B	CLPT-DL	CLPT-DF

\* Refers to 8CLPT and 8NCLPT-A or -B fuses only.

\*\* See page 70 for dimensions and diagrams of typical mounting.

\*\*\* End fittings supplied only when required.

<sup>†</sup> Disconnect mountings provide a means for fuse extraction only. Do not use a disconnect mounting for load switching or fuse removal while energized.

Dimensions (see catalog number tables for values)

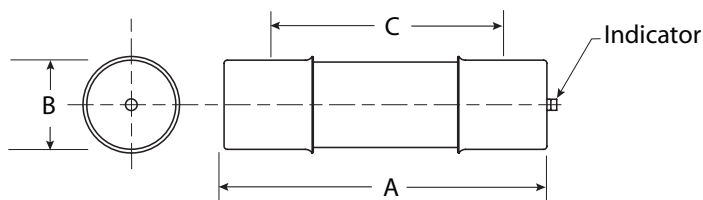

Recommended fuseclips:

Description	Cat. No.
Open fuseclip for 0.8 (20 mm) dia. fuses	1A1837
Open fuseclip for 1.0 (25.4 mm) dia. fuses	A3354705
Open fuseclip for 1.56 (39.7 mm) / 1.6 (40.6 mm) dia. fuses	1A0835



8.3 kV time-current curves — minimum melting for 8NCLPT\_

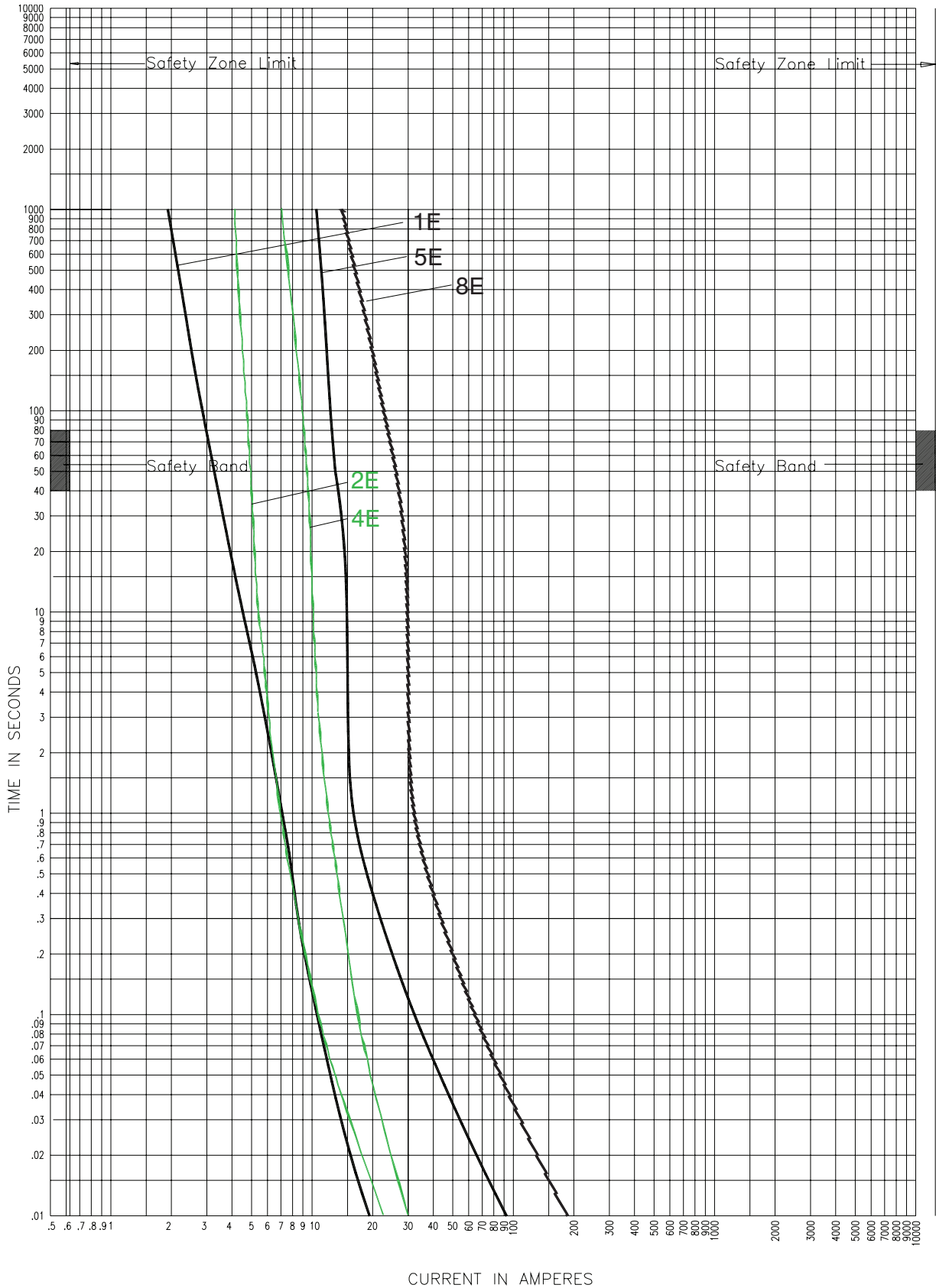

8NCLPT\_

Curve 59887102  
July 2002  
Reference # 628852, 598871

Curve TC56357206  
December 2008

8.3 kV time-current curves — total clearing for 8NCLPT\_

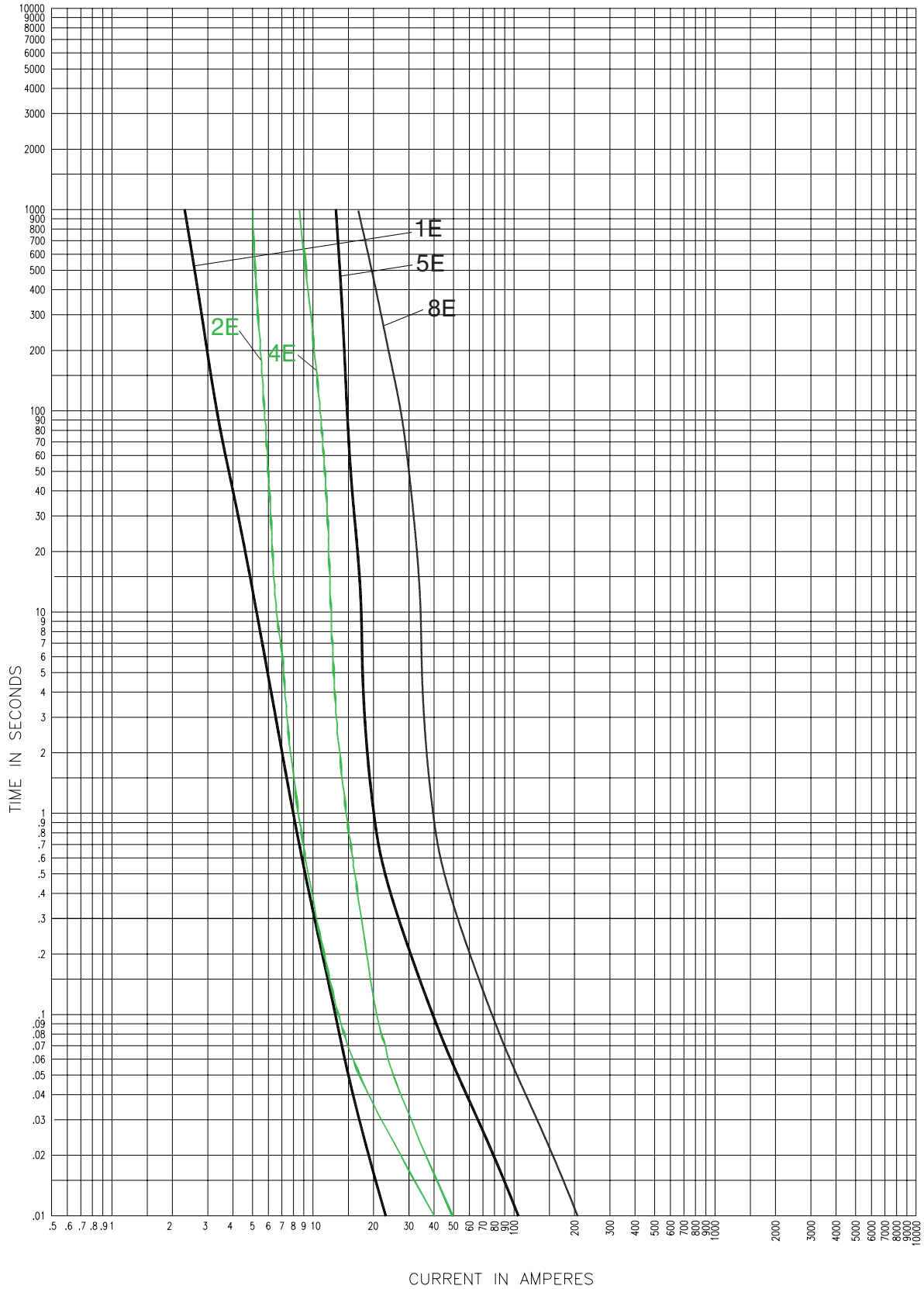

8NCLPT\_

Curve 59887104  
July 2002  
Reference # 598871

Curve TC59883706  
December 2008



8.3 kV peak let-through curves for 8NCLPT\_

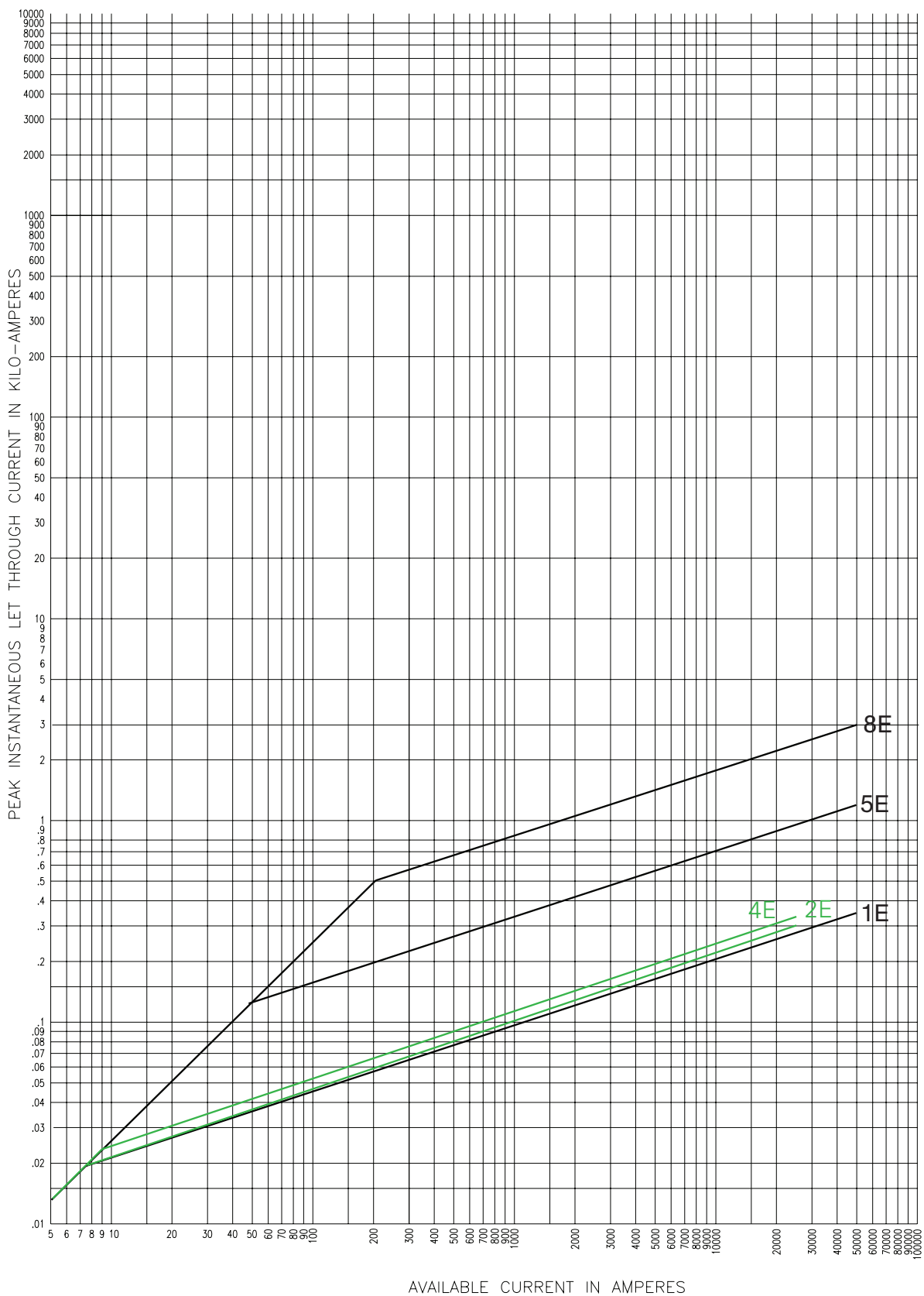

8NCLPT\_

Curve 63933703  
July 2001  
Reference # 639337

Curve TC63933704  
December 2008

8.3 kV time-current curves — minimum melting for 8CLPT\_

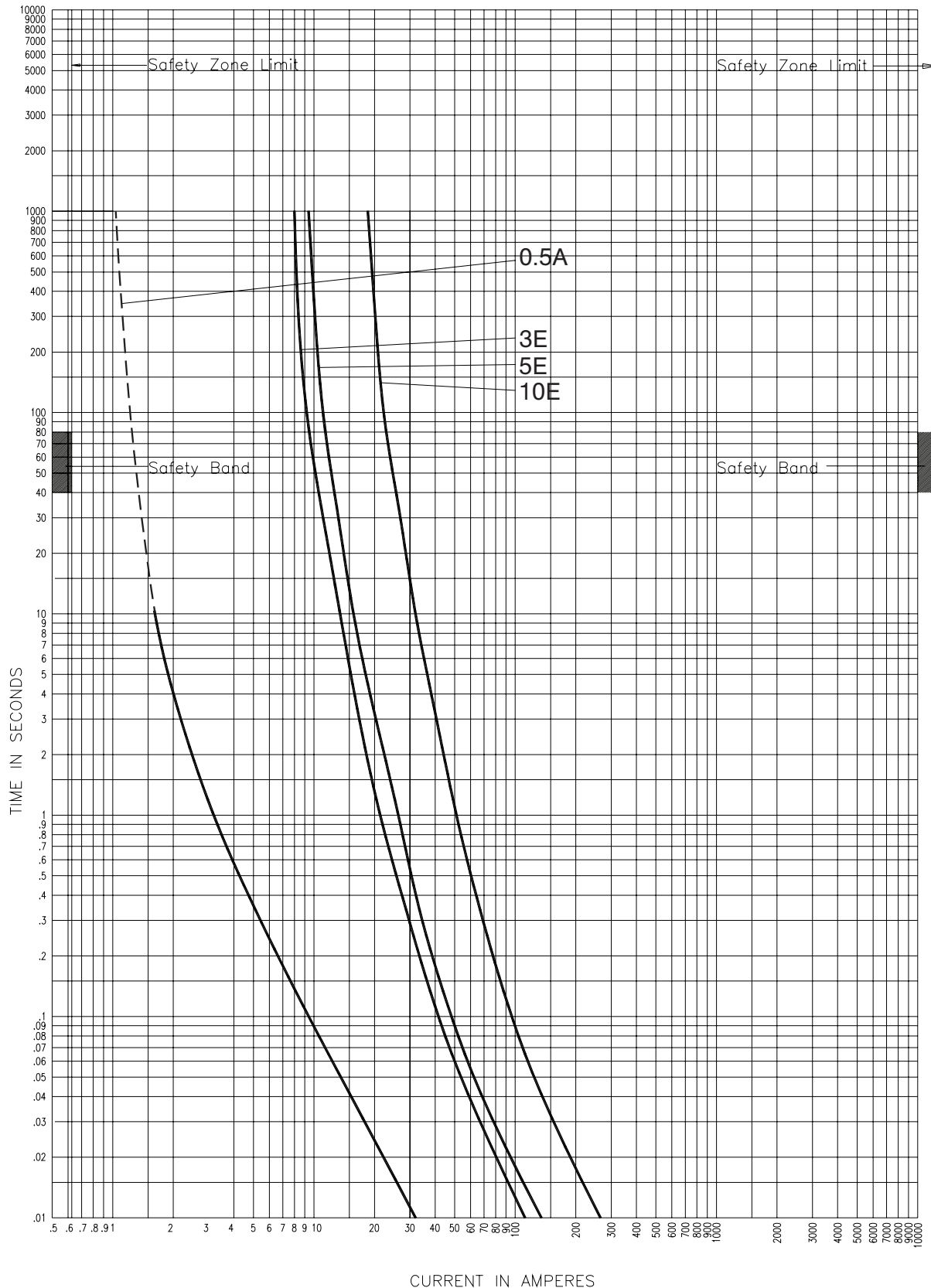

0.5 A fuse melt time in the dotted line region may not be assured due to manufacturing variations. The dotted lines show nominal operation. Some individual fuses may not open until current at 10-second mark is applied.

Curve TC56353206  
December 2013

8CLPT\_

8.3 kV time-current curves — total clearing for 8CLPT\_

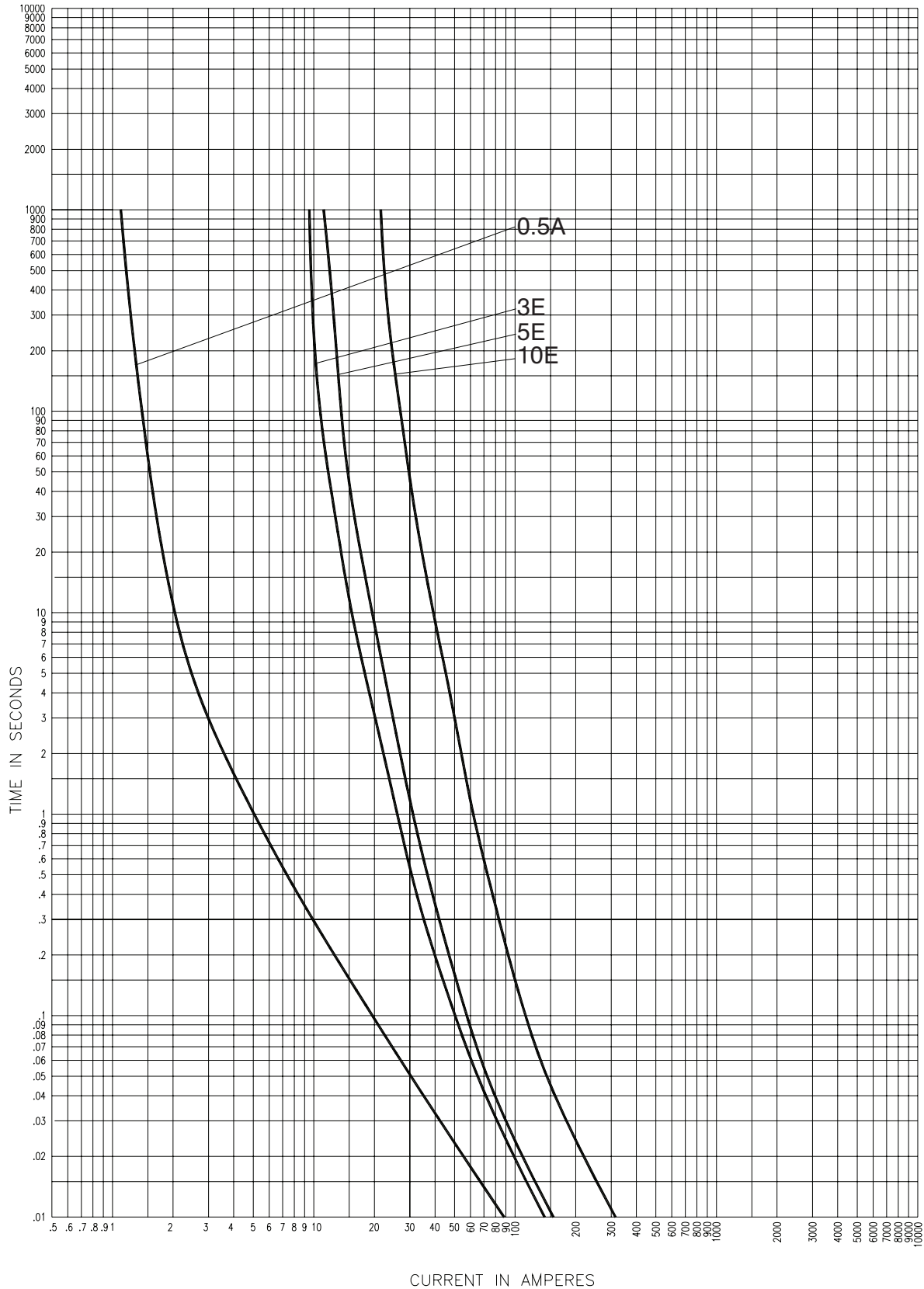

8CLPT\_

Curve TC56353306  
March 2013

8.3 kV peak let-through curves for 8CLPT\_

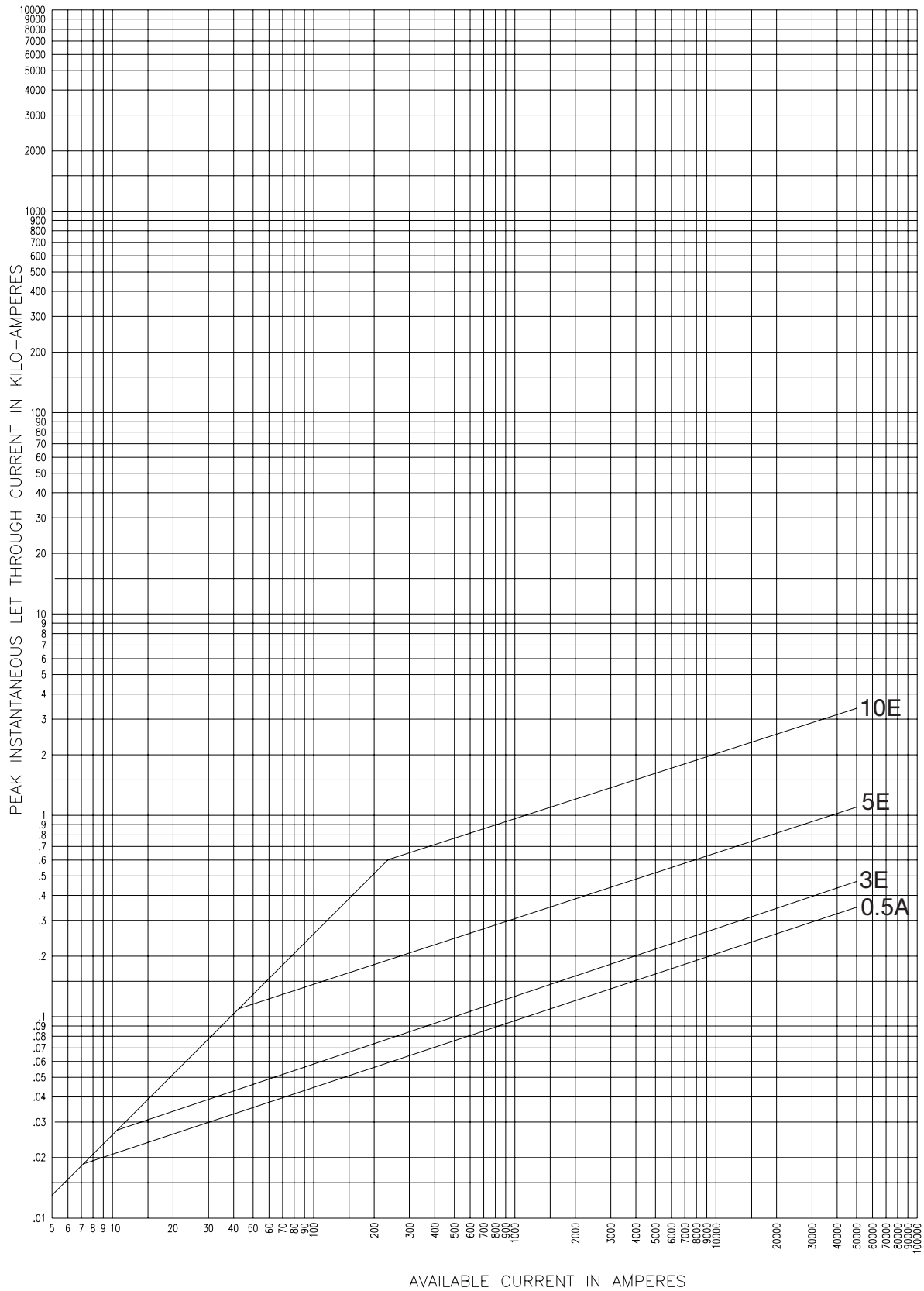

8CLPT\_

Curve TC63934001  
March 2013

8.3 kV time-current curves — minimum melting for 8NCLPT\_E-A/B

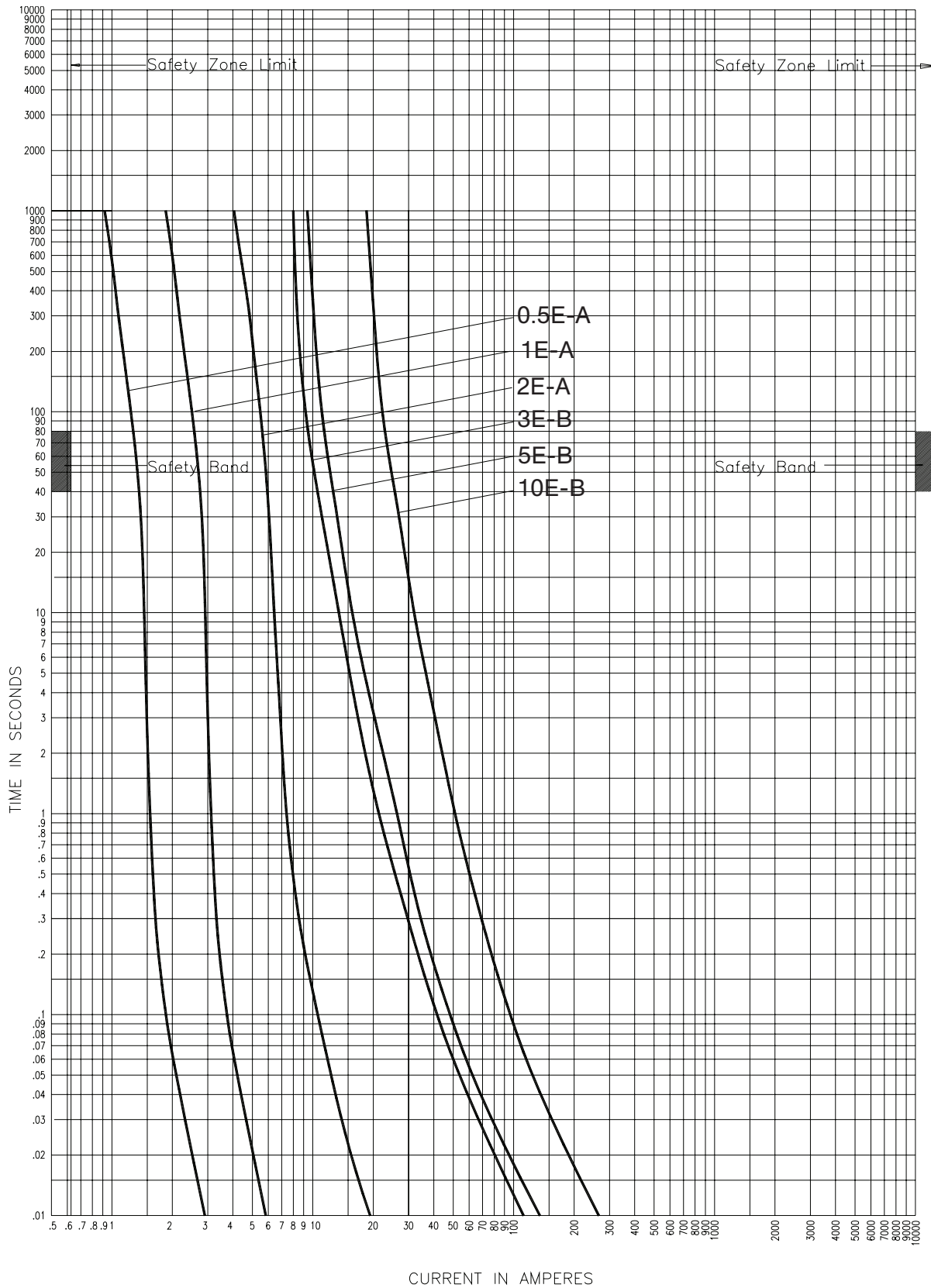

8NCLPT\_E-A/B

Curve TC70548303  
December 2008

8.3 kV time-current curves — total clearing for 8NCLPT\_E--A/B

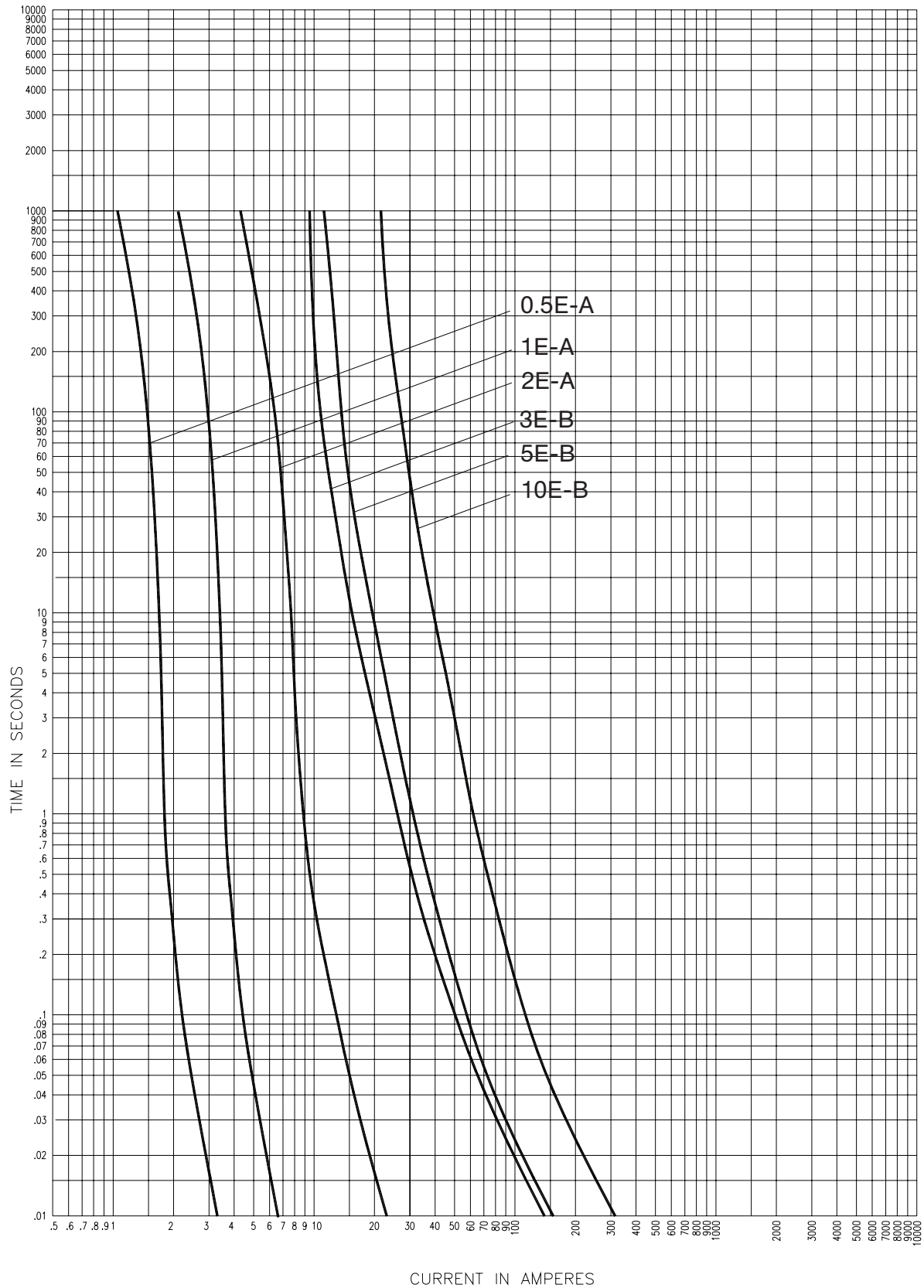

8NCLPT\_E-A/B

Curve TC70548403  
December 2008

8.3 kV peak let-through curves for 8NCLPT\_E-A/B

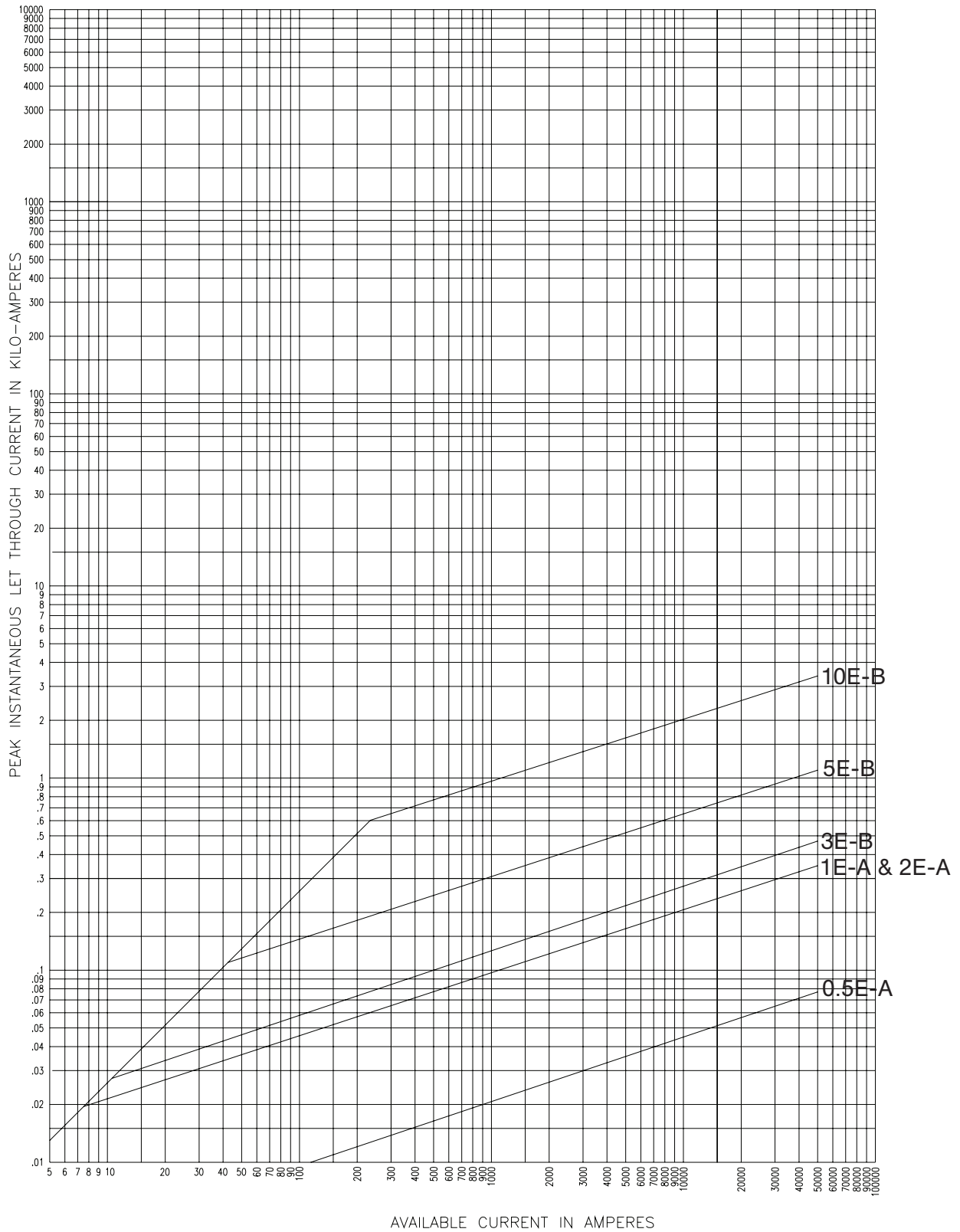

8NCLPT\_E-A/B

Curve TC63934002  
December 2008

12 kV maximum system voltage

Amp rating	Dimensions - in (mm)			Catalog No. (Interrupting rating - kA)		Recommended fuseclip
	Length A	Diameter B	Clip centers C	Indicating	Non-indicating	
2	8.7 (221)	1.6 (41)	7.5 (190)	—	12CAV2 (40)	1A0835
3.15	7.7 (195)	1 (25)	6.5 (165)	—	12ABCNA3.15 (45)	A3354705

Dimensions (see catalog number tables for values)

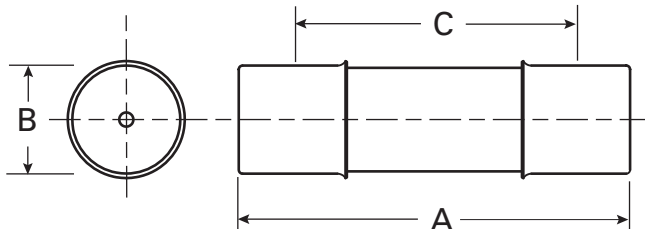

Recommended fuseclips:

Description	Cat. No.
Open fuseclip for 1.0 (25.4 mm) dia. fuses	A3354705
Open fuseclip for 1.56 (39.7 mm) / 1.6 (40.6 mm) dia. fuses	1A0835



12 kV time-current curves — minimum melting for 12ABC\_ and 12CAV\_

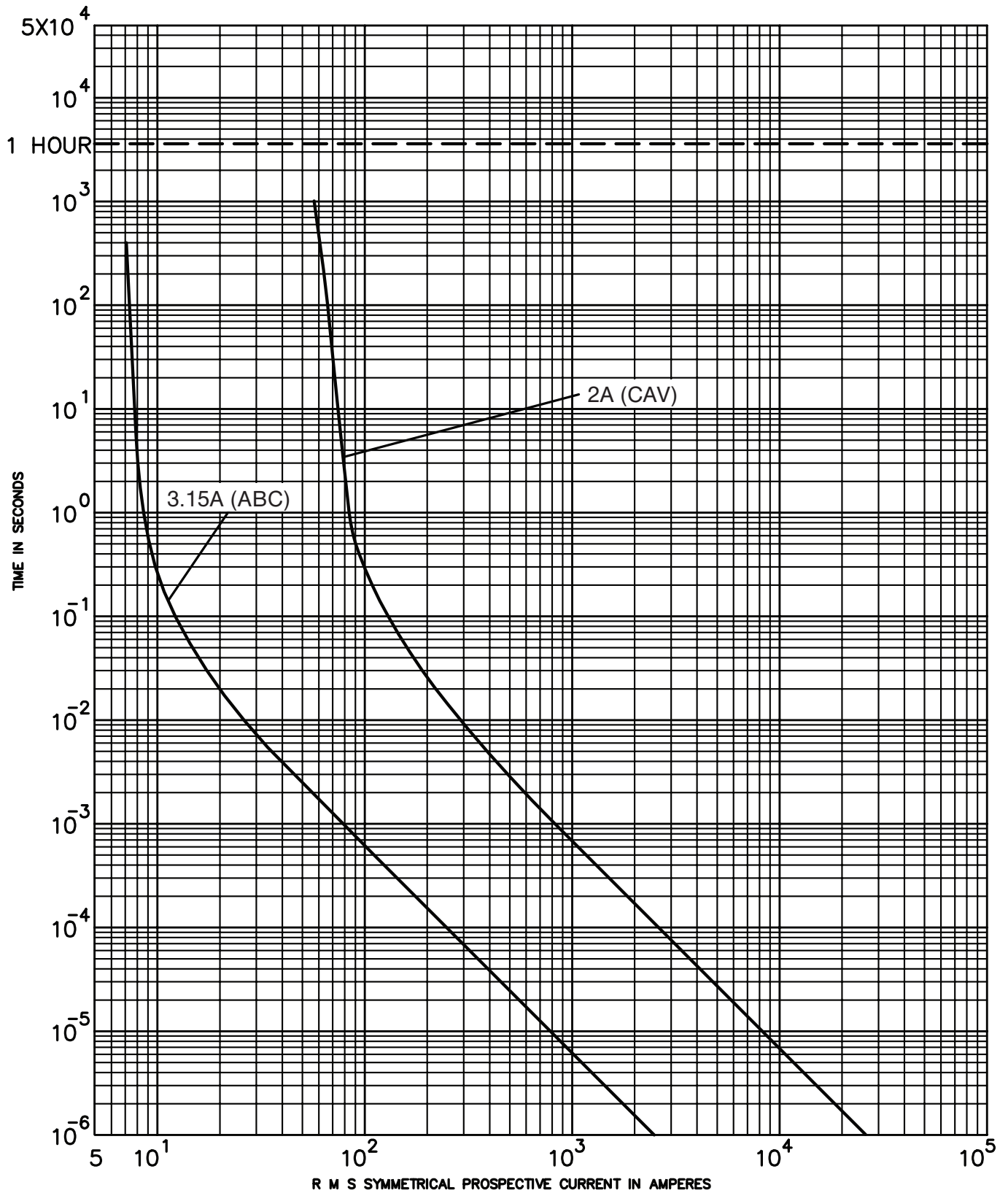

12ABC\_, 12CAV\_

12 kV peak let-through curves for 12ABC\_

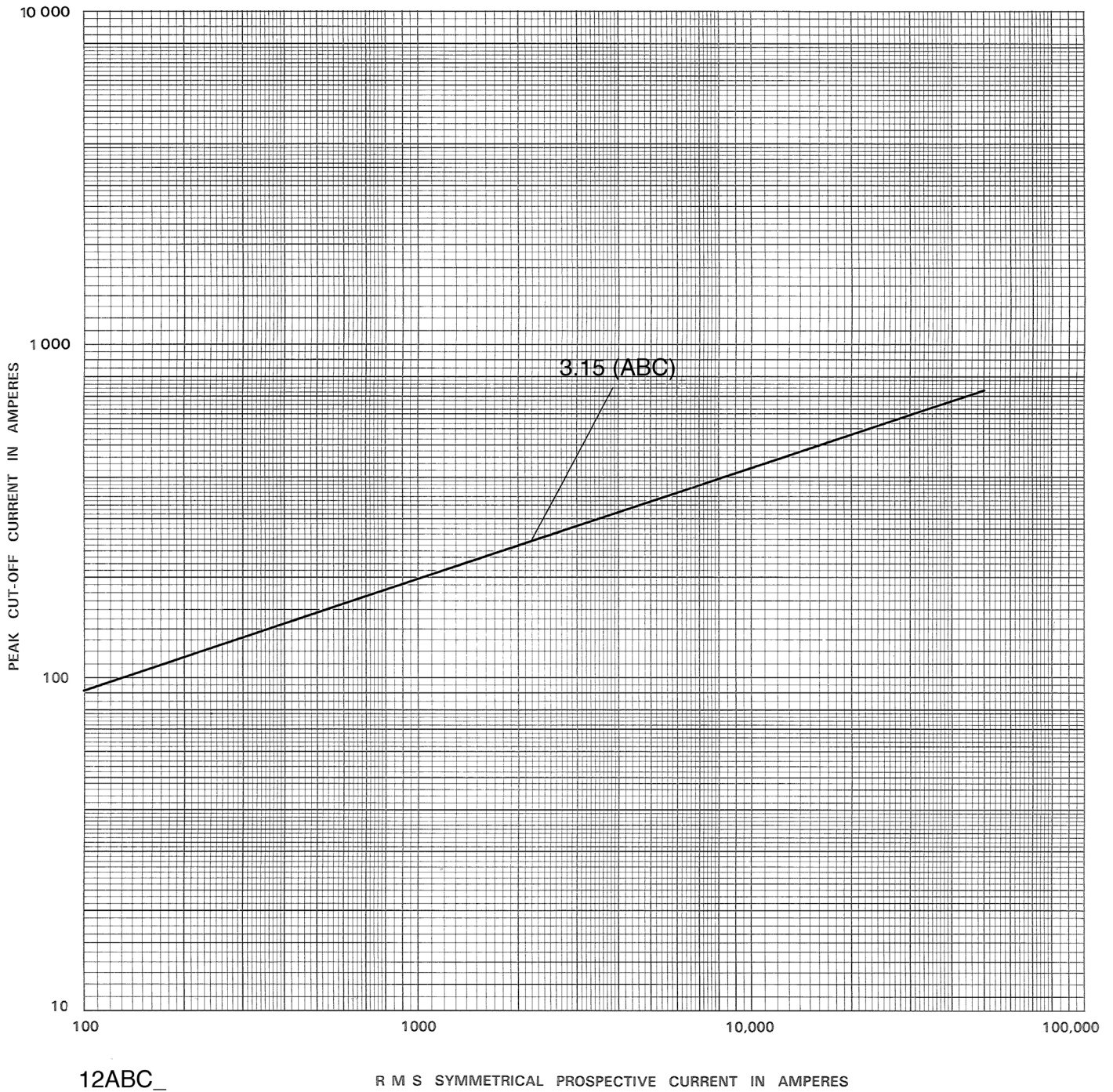

15.5 kV maximum system voltage

Amp rating	Dimensions - in (mm)			Catalog No. (Interrupting rating - kA)		Recommended fuseclip
	Length A	Diameter B	Clip centers C	Indicating	Non-indicating	
0.5	12.9 (328)	1.6 (41)	11.5 (292)	15.5CAVH0.5E (80)	15NCLPT-5E-A (50)	1A0835
1	12.9 (328)	1.6 (41)	11.5 (292)	15.5CAVH1E (80)	15NCLPT-1E-A (50)	
2	12.9 (328)	1.6 (41)	11.5 (292)	15.5CAVH2E (80)	15NCLPT-2E (50)	
3	12.9 (328)	1.6 (41)	11.5 (292)	—	15.5CAV3E (80)	
3	17.6 (447)	1.6 (41)	16.1 (409)	—	15NCLPT-3E (50)	
3	17.6 (447)	1.6 (41)	16.1 (409)	15CLPT-3E (50)	—	
5	12.9 (328)	1.6 (41)	11.5 (292)	—	15.5CAV5E (80)	
5	17.6 (447)	1.6 (41)	16.1 (409)	15CLPT-5E (50)	15NCLPT-5E (50)	
7	12.9 (328)	1.6 (41)	11.5 (292)	—	15.5CAV7E (80)	
10	17.6 (447)	1.6 (41)	16.1 (409)	15CLPT-10E (50)	15NCLPT-10E (50)	

CLPT Type mountings and hardware 15.5 kV maximum (14.4 kV nominal)

Amp rating	Fuse mounting type*	BIL (kV)	Catalog number			
			Mounting (Including live parts, end fittings)**		Live parts (including end fittings)**	End fittings (disconnect only)
			Porcelain insulator	Glass-polyester insulator		
0.5-2	Non-disconnect	95	15CLPT-PNM-A	15CLPT-GNM-A	CLPT-NL	—
	Disconnect†	95	15CLPT-PDM-A	15CLPT-GDM-A	CLPT-DL	CLPT-DF
3-10	Non-disconnect	95	15CLPT-PNM-B	15CLPT-GNM-B	CLPT-NL	CLPT-DF
	Disconnect†	95	15CLPT-PDM-B	15CLPT-GDM-B	CLPT-DL	—

\* See page 70 for dimensions and diagrams of typical mounting.

\*\* End fittings supplied only when required.

† Disconnect mountings provide a means for fuse extraction only. Do not use a disconnect mounting for load switching or fuse removal while energized.

Dimensions (see catalog number tables for values)

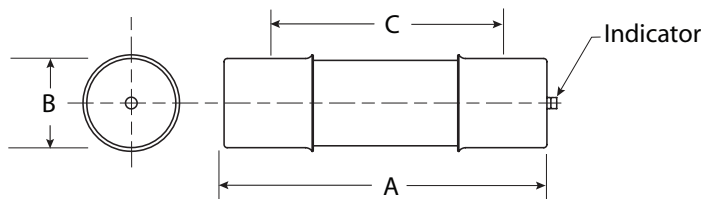

Recommended fuseclips:

Description	Cat. No.
Open fuseclip for 1.56 (39.7 mm) / 1.6 (40.6 mm) dia. fuses	1A0835

15.5 kV time-current curves — minimum melting for 15CLPT\_

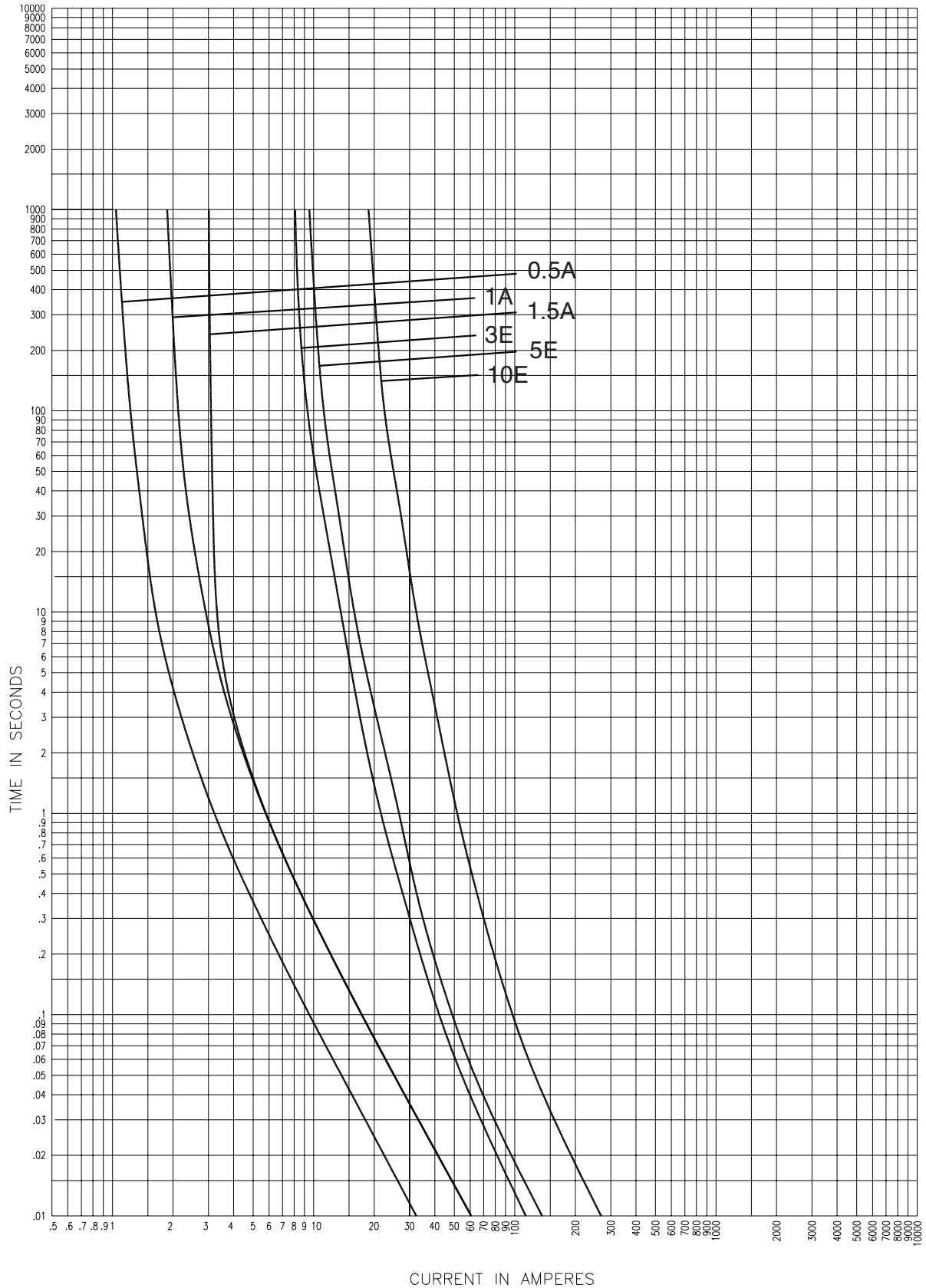

15CLPT\_

Curve TC56353206  
August 2011

15.5 kV time-current curves — total clearing for 15CLPT\_

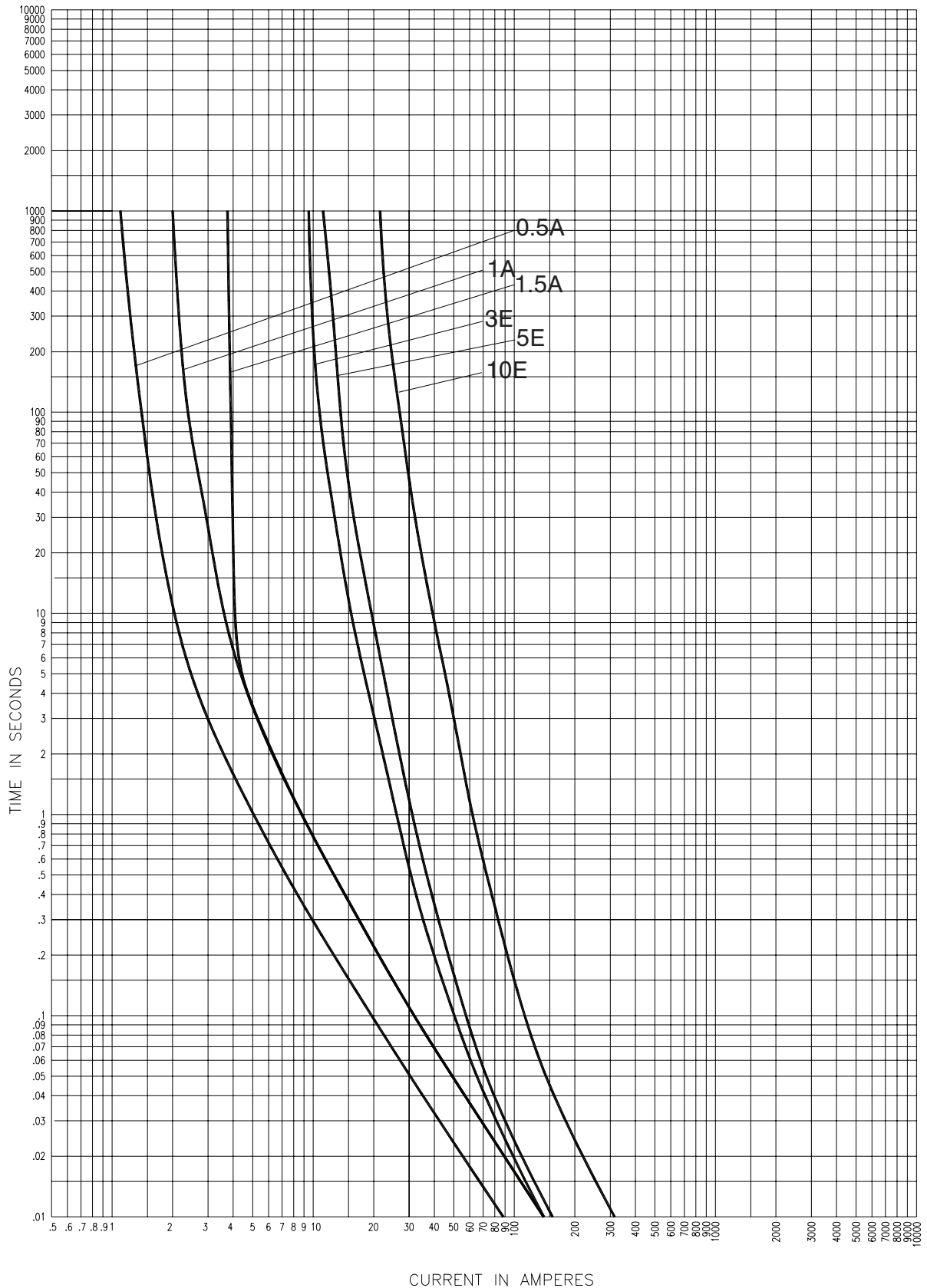

15CLPT-\_E

CURVE 56353306  
July 2002  
Reference # 563533

15.5 kV peak let-through curves for 15CLPT\_

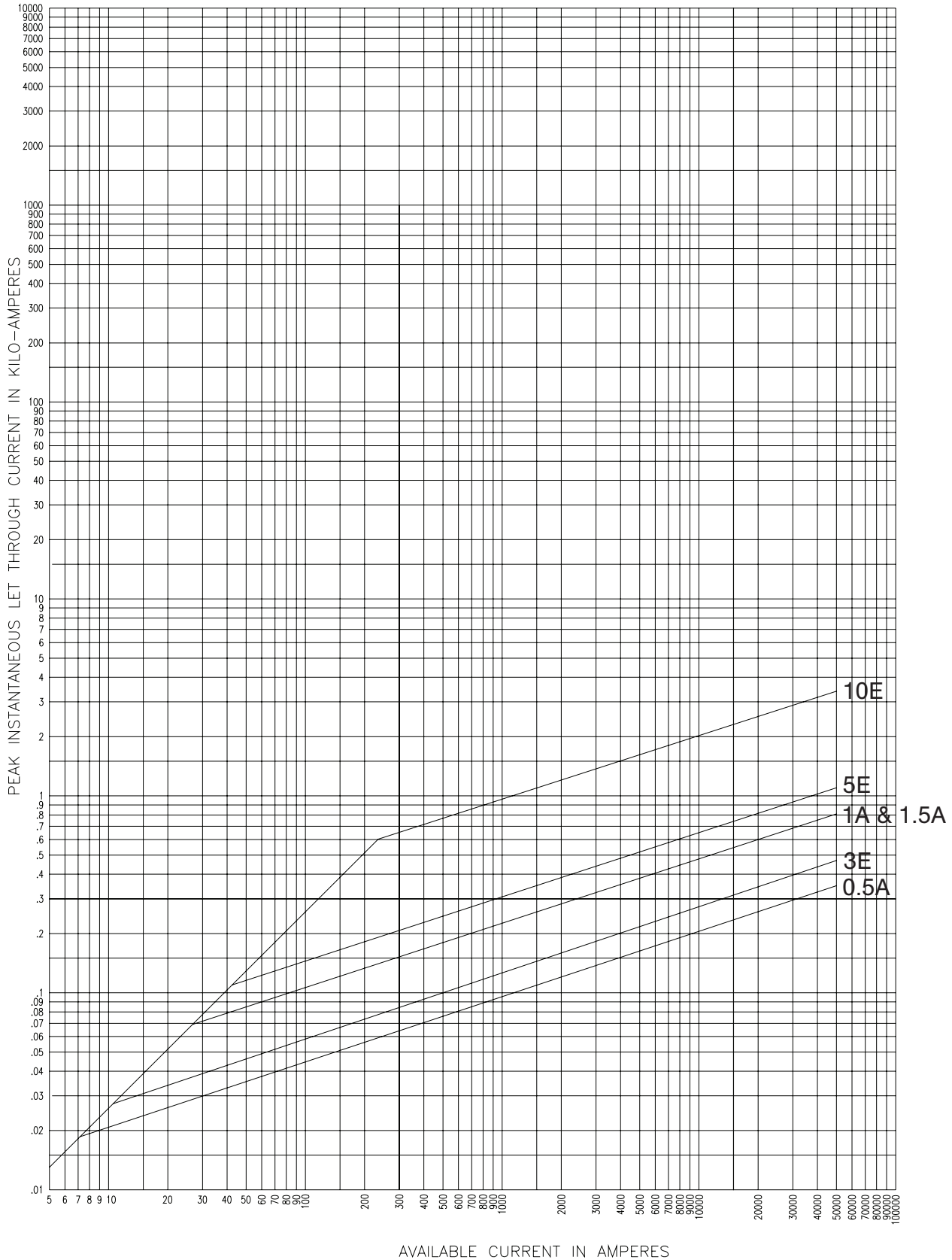

15CLPT-    

Curve TC63934001  
March 2013

15.5 kV time-current curves — minimum melting for 15NCLPT\_

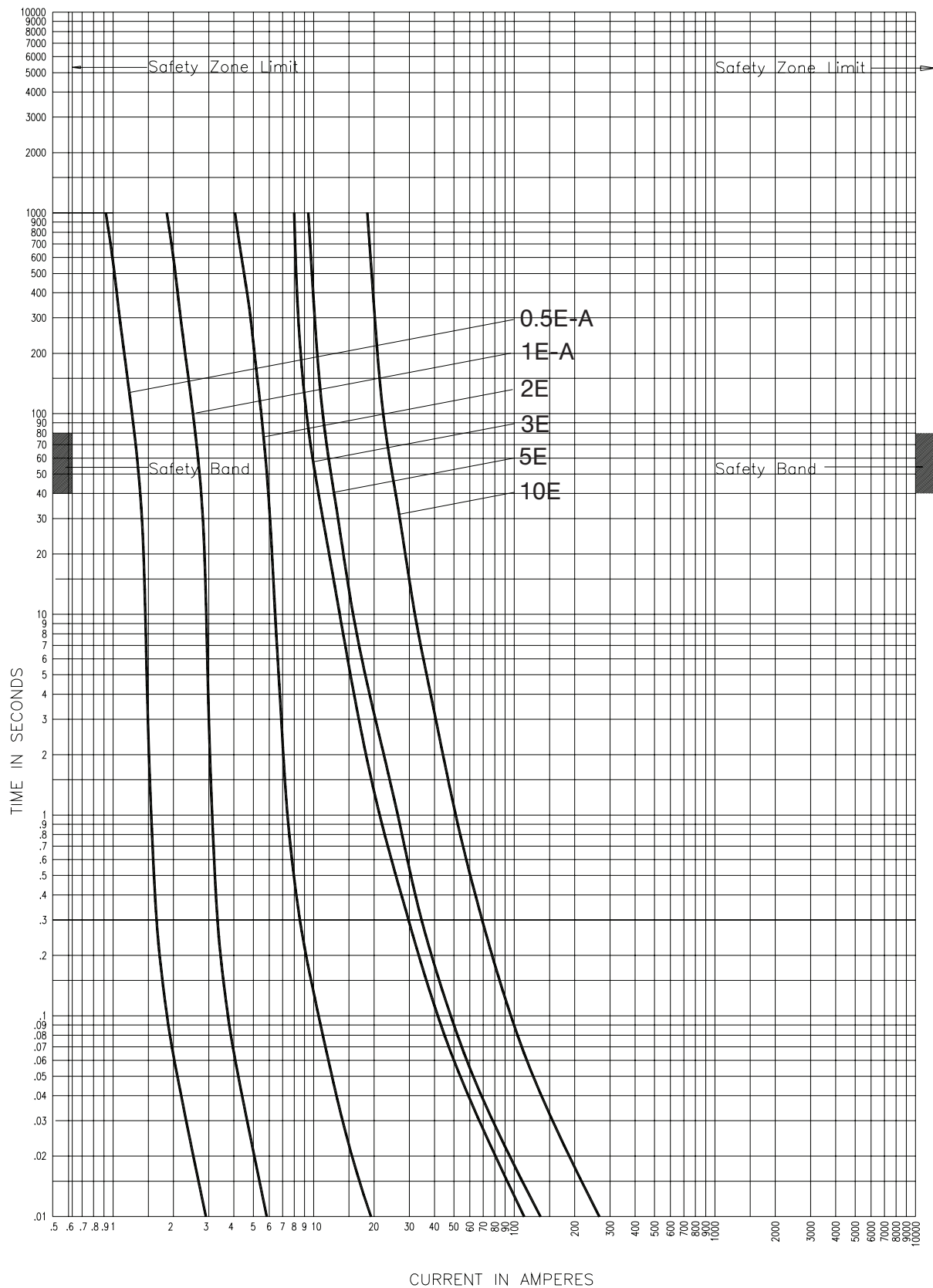

15NCLPT\_

Curve TC70548303  
December 2008

15.5 kV Time-current curves — total clearing for 15NCLPT\_

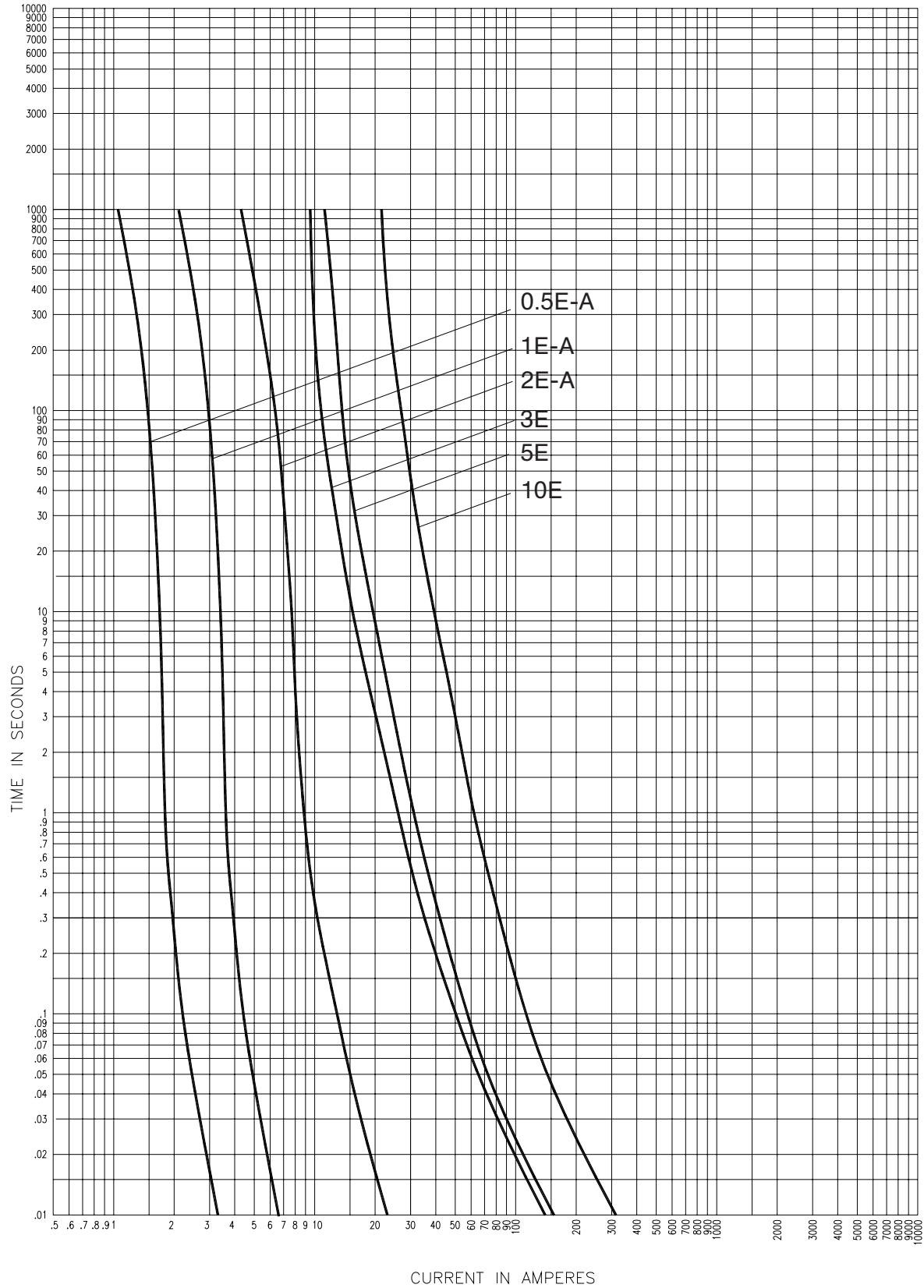

15NCLPT\_

Curve TC70548403  
December 2008



15.5 kV Peak let-through curves for 15NCLPT\_

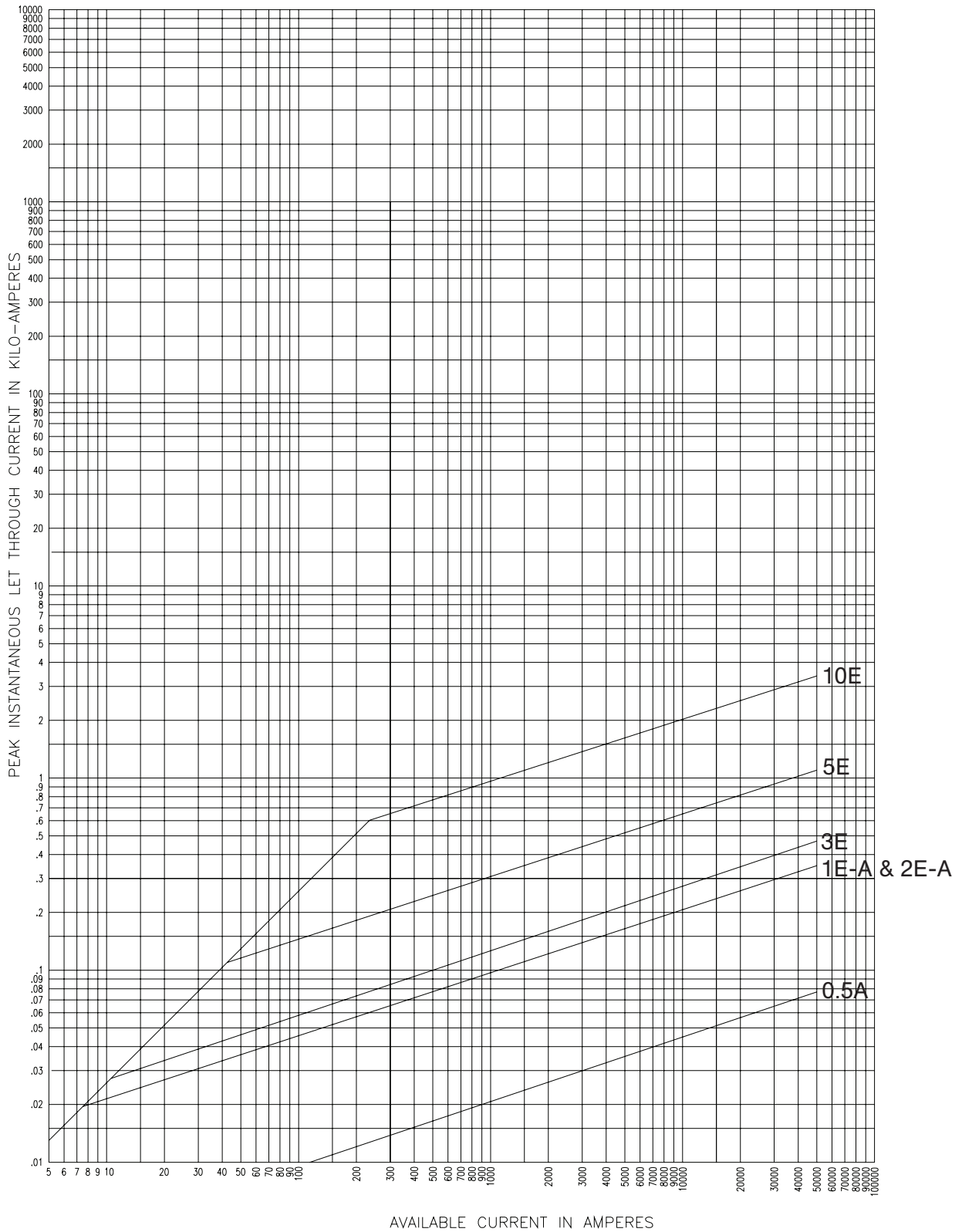

15NCLPT\_

Curve TC63934002  
December 2008

15.5 kV time-current curves — minimum melting for 15.5CAV\_ and 15.5CAVH\_

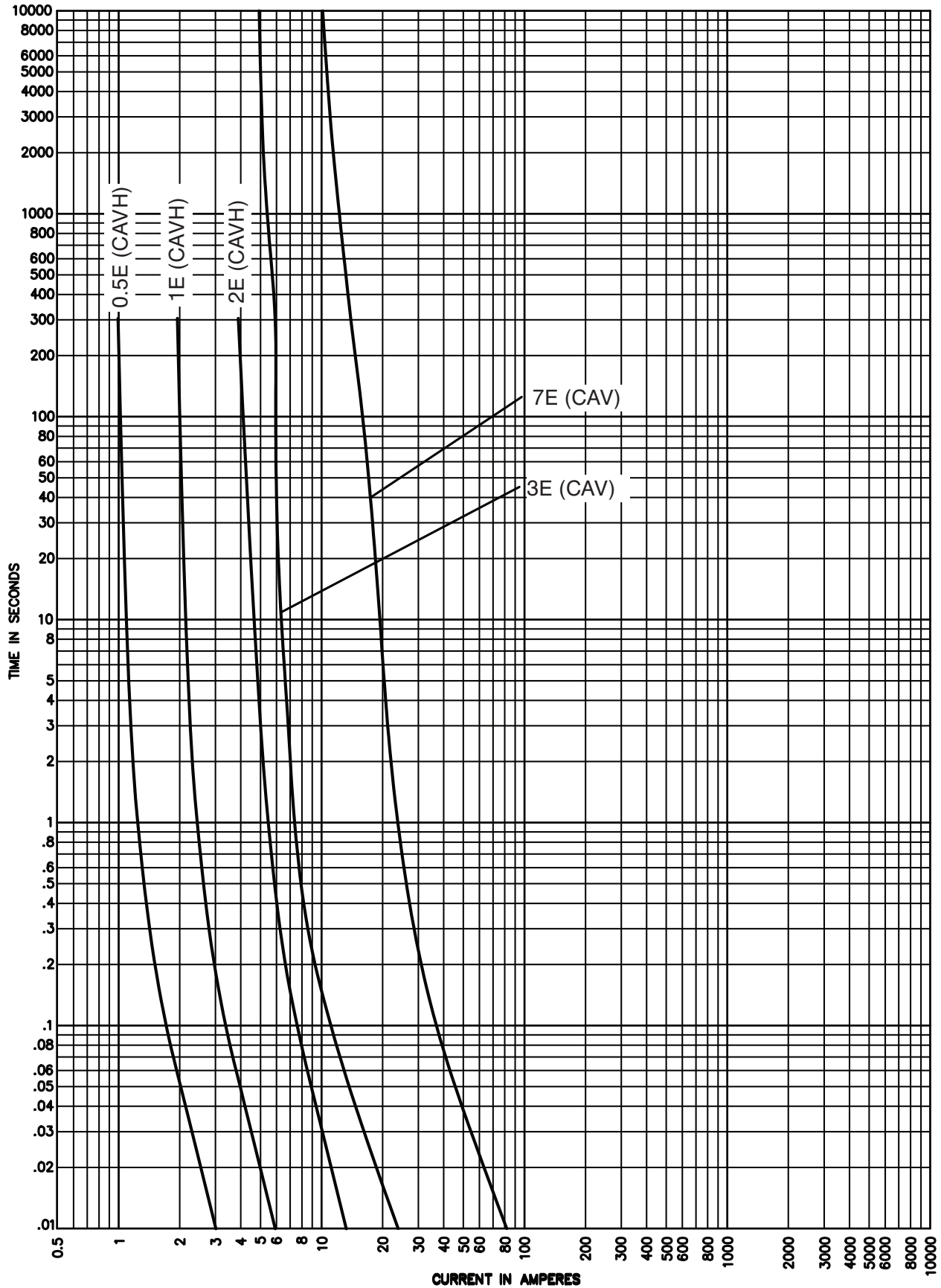

15.5CAV\_, 15.5CAVH\_

15.5 kV time-current curves — total clearing for 15.5CAVH\_

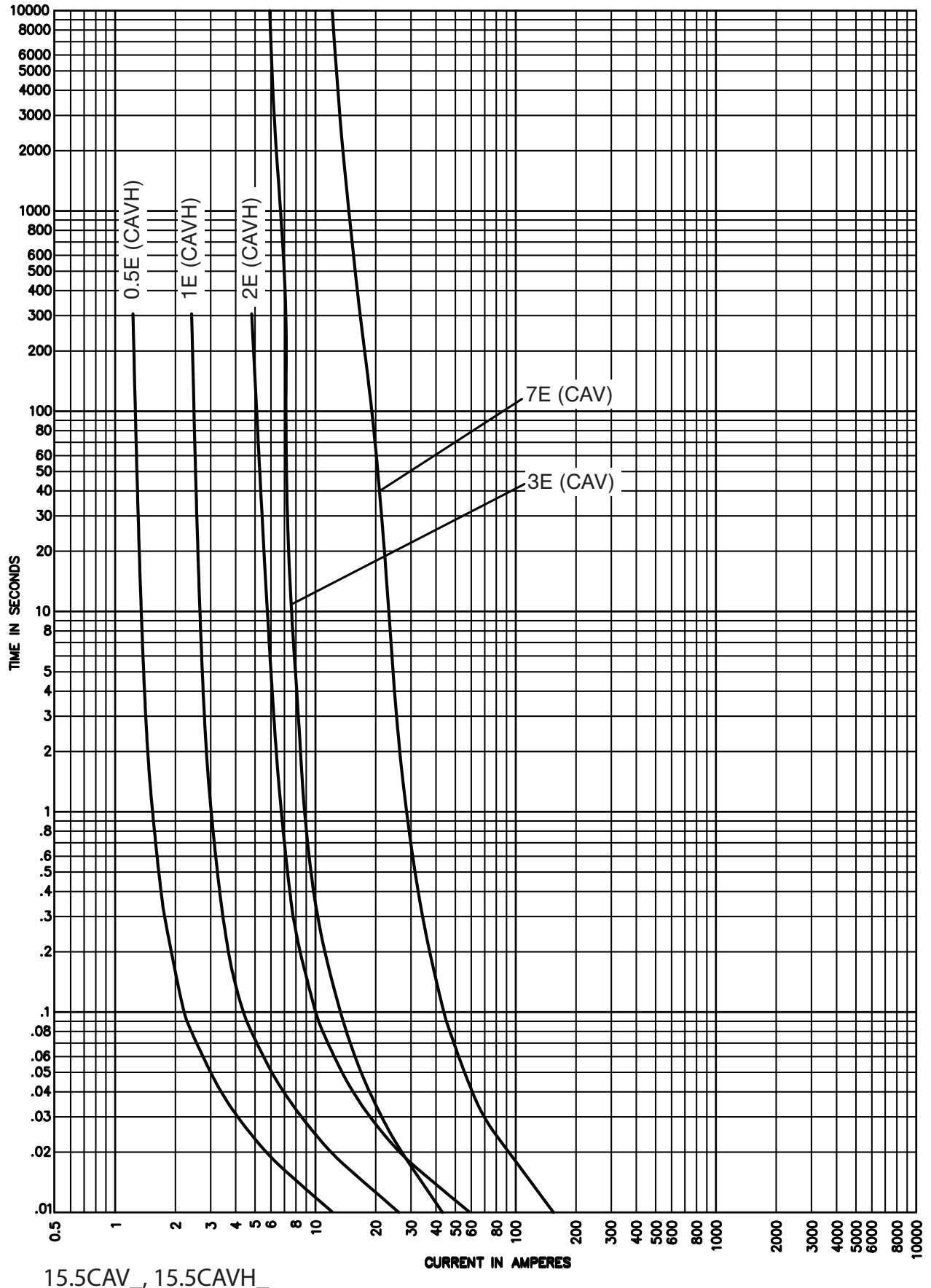

15.5CAV\_, 15.5CAVH\_

15.5 kV peak let-through curves for 15.5CAVH\_

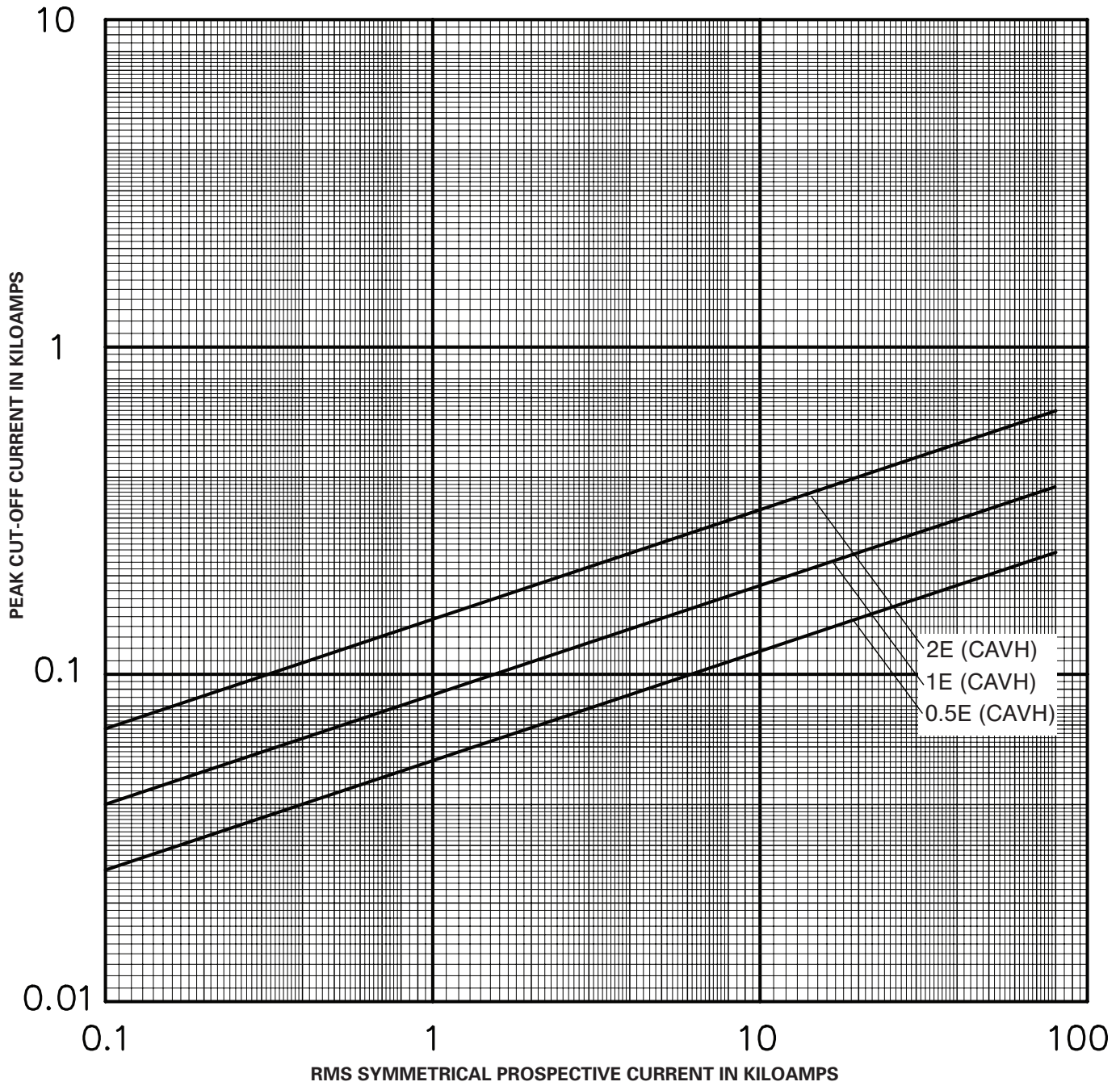

15.5CAVH\_

17.5 kV maximum system voltage

Amp rating	Dimensions - in (mm)			Catalog No. (Interrupting rating - kA)		Recommended fuseclip
	Length A	Diameter B	Clip centers C	Indicating	Non-indicating	
2	8.7 (221)	1.6 (41)	7.5 (190)	—	17.5CAV2 (40)	1A0835
4				—	17.5CAV4 (40)	
6				—	17.5CAV6 (40)	
10				—	17.5CAV10 (40)	

Dimensions (see catalog number tables for values)

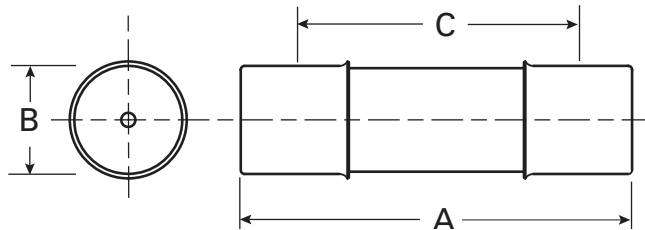

Recommended fuseclips:

Description	Cat. No.
Open fuseclip for 1.56 (39.7 mm) / 1.6 (40.6 mm) dia. fuses	1A0835

17.5 kV time-current curves — minimum melting for 17.5CAV\_

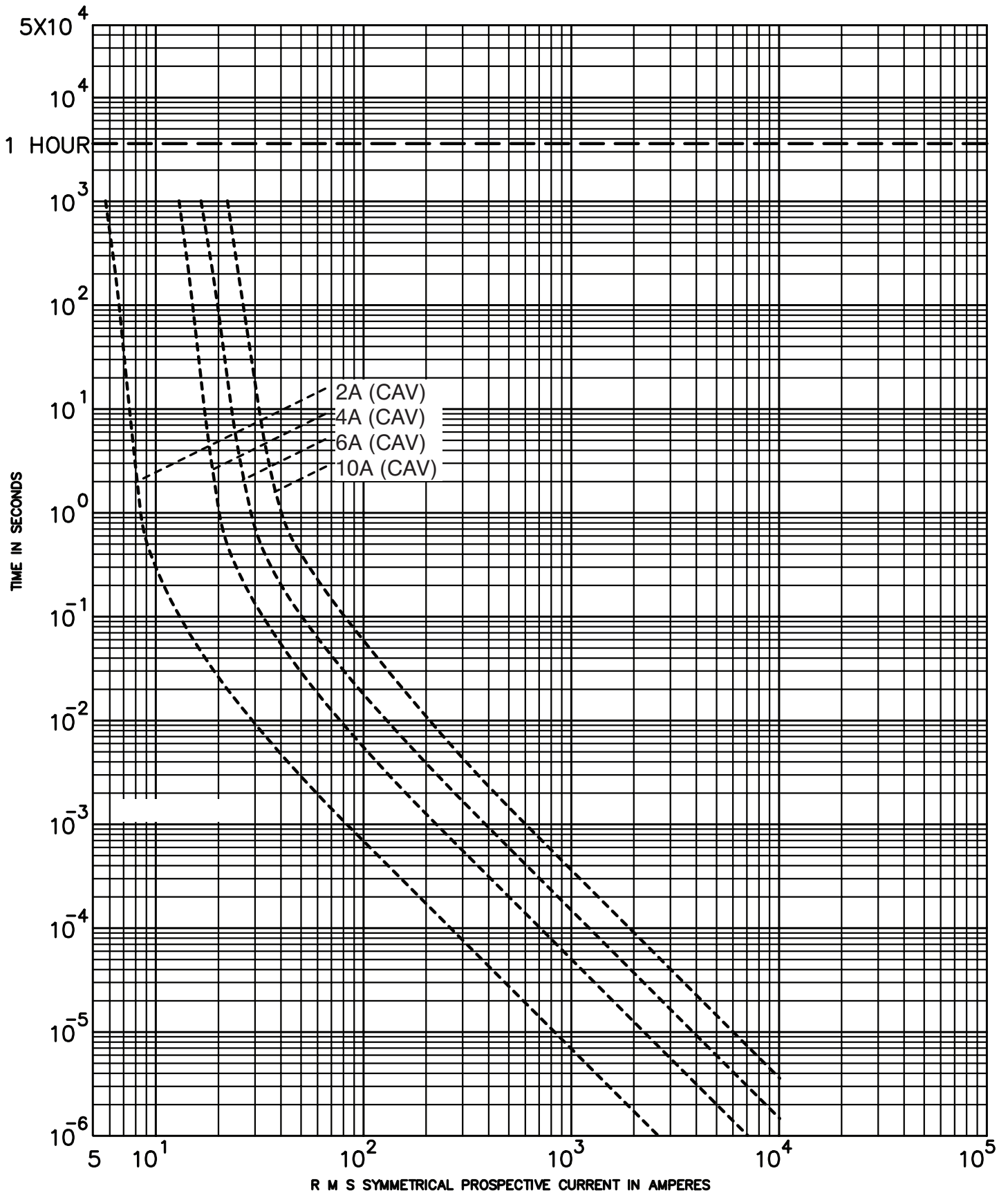

24 kV maximum system voltage

Amp rating	Dimensions - in (mm)			Catalog No. (Interrupting rating - kA)		Recommended fuseclip
	Length A	Diameter B	Clip centers C	Indicating	Non-indicating	
2				—	24CAV2 (40)	
3	13.49 (340)	1.6 (41)	12.2 (310)	—	24CAV3 (40)	1A0835
4				—	24CAV4 (40)	

Dimensions (see catalog number tables for values)

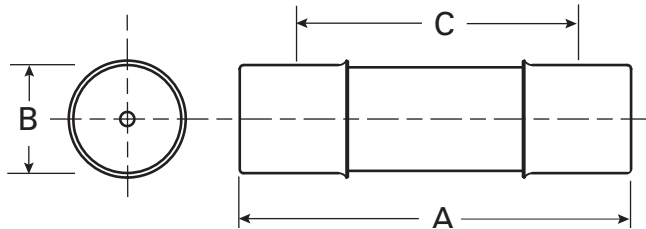

Recommended fuseclips:

Description	Cat. No.
Open fuseclip for 1.56 (39.7 mm) / 1.6 (40.6 mm) dia. fuses	1A0835

24 kV time-current curves — minimum melting for 24CAV\_

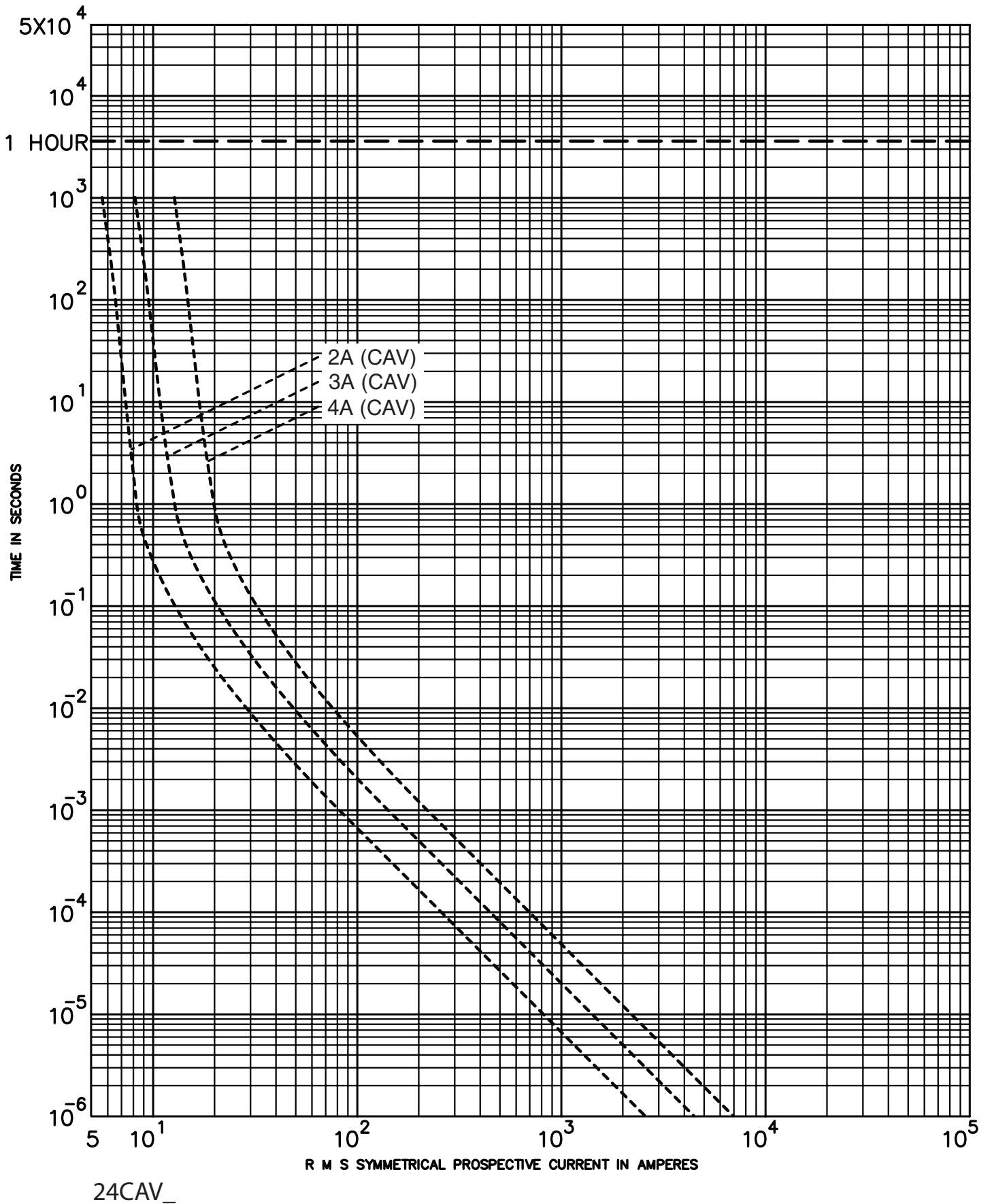



25.5 kV maximum system voltage

Amp rating	Dimensions - in (mm)			Catalog No. (interrupting rating - kA)		Recommended fuseclip
	Length A	Diameter B	Clip centers C	Indicating	Non-indicating	
0.5	17.6 (447)	1.6 (41)	16.1 (410)	25CLPT-5 (43.5) <sup>†</sup>	—	1A0835
1	17.6 (447)	1.6 (41)	16.1 (410)	25CLPT-1 (43.5) <sup>†</sup>	—	

<sup>†</sup> Does not comply with ANSI C37.46 for “E” rating.

CLPT Type Mountings and Hardware 25.5 kV Maximum (23 kV Nominal)

Amp rating	Fuse mounting type*	BIL (kV)	Catalog number			
			Mounting (including live parts, end fittings)**		Live parts (including end fittings)**	End fittings (disconnect only)
			Porcelain insulator	Glass-polyester insulator		
0.5-1	Non-disconnect	150	25CLPT-PNM-A	—	25CLPT-NL	—
	Disconnect	150	25CLPT-PDM-A	—	25CLPT-DL	CLPT-DF

\* See page 70 for dimensions and diagrams of typical mounting.

\*\* End fittings supplied only when required.

<sup>†</sup> Disconnect mountings provide a means for fuse extraction only. Do not use a disconnect mounting for load switching or fuse removal while energized.

Dimensions (see catalog number tables for values)

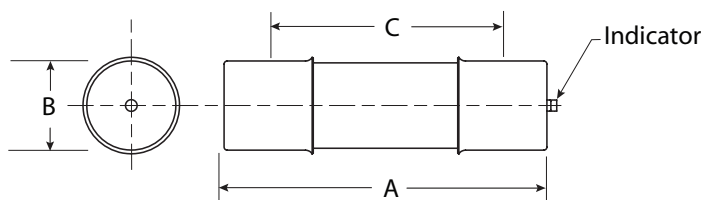

Recommended fuseclips:

Description	Cat. No.
Open fuseclip for 1.56 (39.7 mm) / 1.6 (40.6 mm) dia. fuses	1A0835

25.5 kV time-current curves — minimum melting for 25CLPT\_

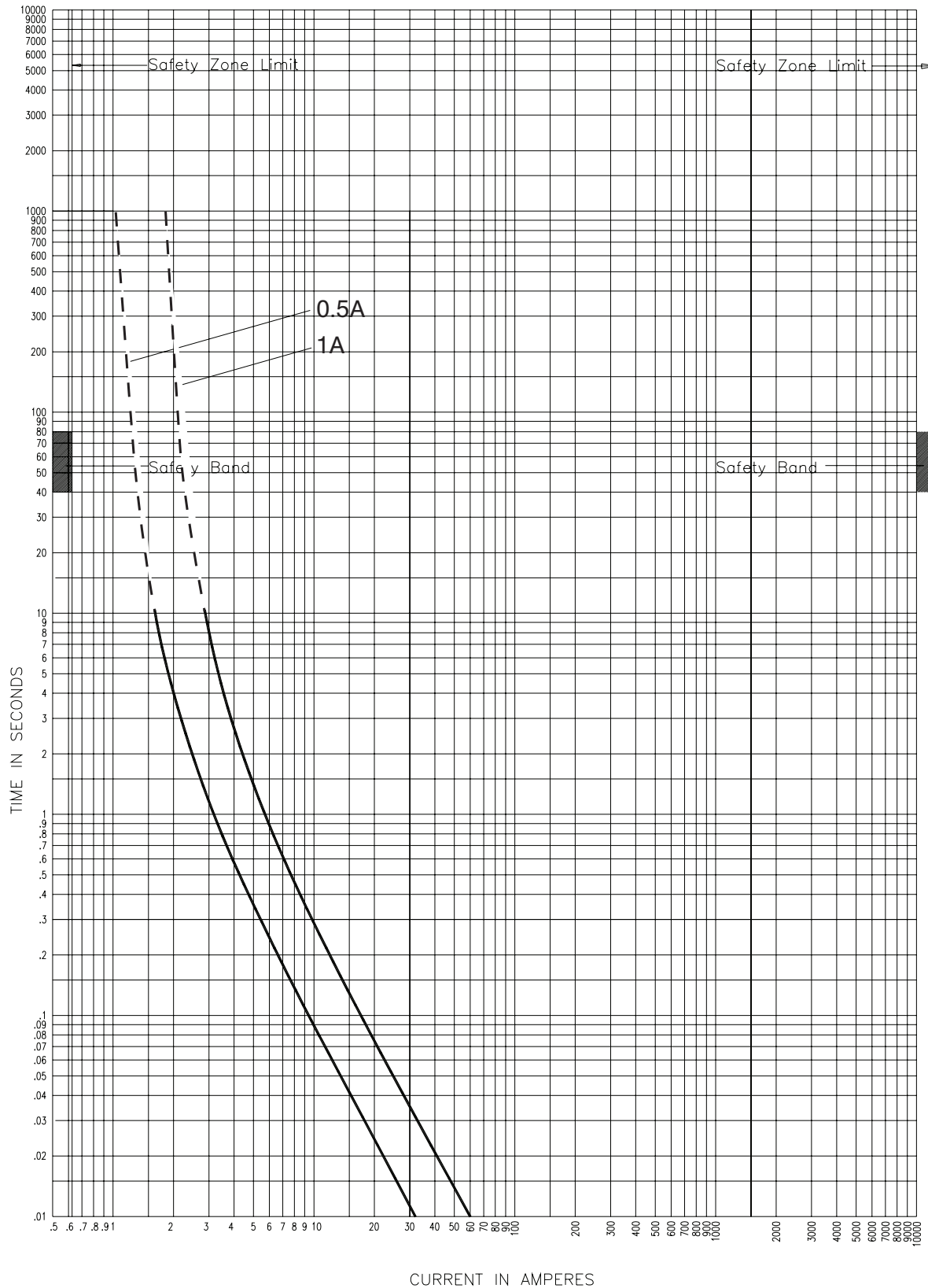

0.5, and 1 A fuse melt times in the dotted line region may not be assured due to manufacturing variations. The dotted lines show nominal operation. Some individual fuses may not open until current at 10-second mark is applied.

Curve TC56353208  
December 2008

25CLPT\_

25.5 kV time-current curves — total clearing for 25CLPT\_

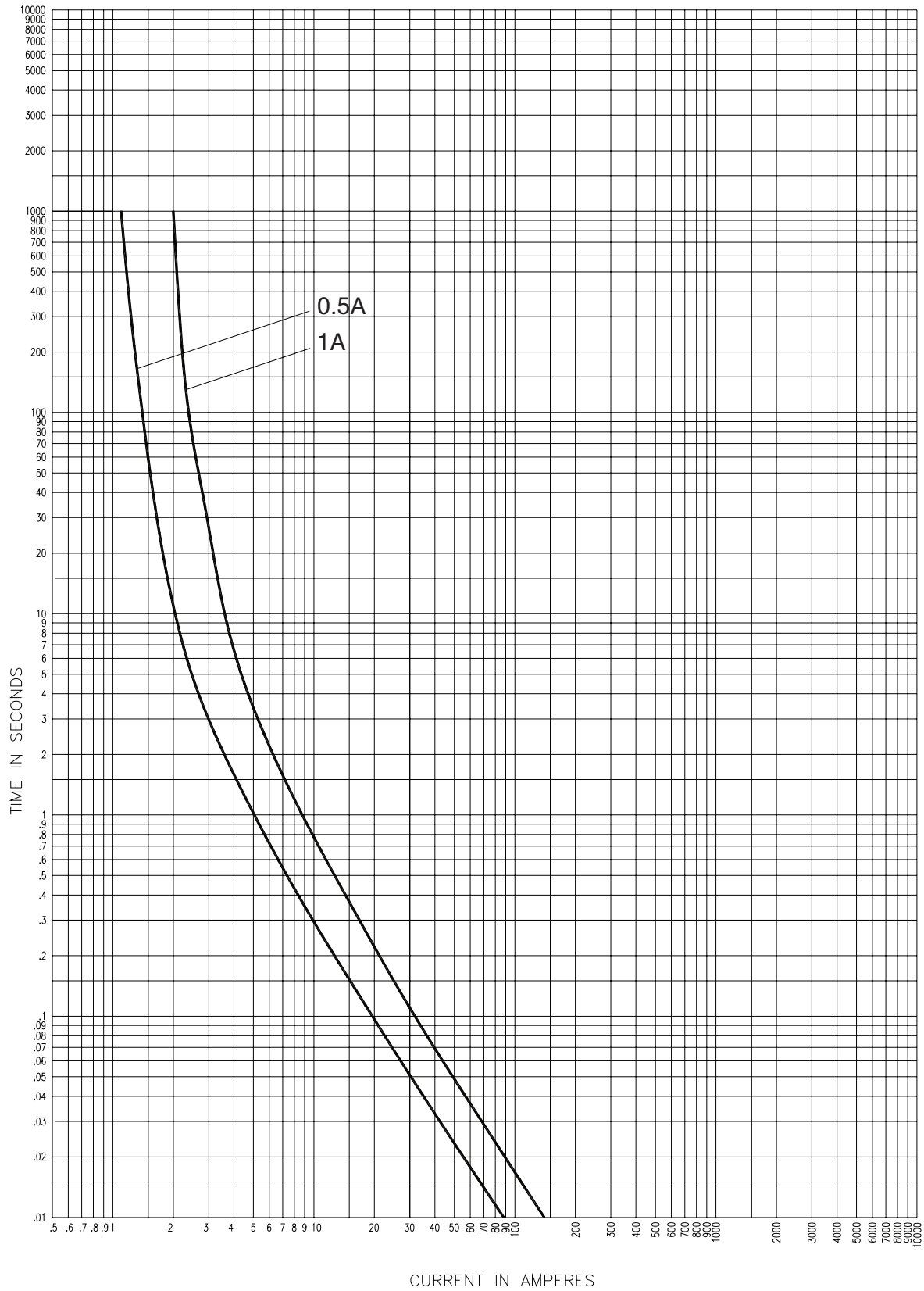

25CLPT\_

Curve TC56353308  
December 2008

25.5 kV Peak let-through curves for 25CLPT\_

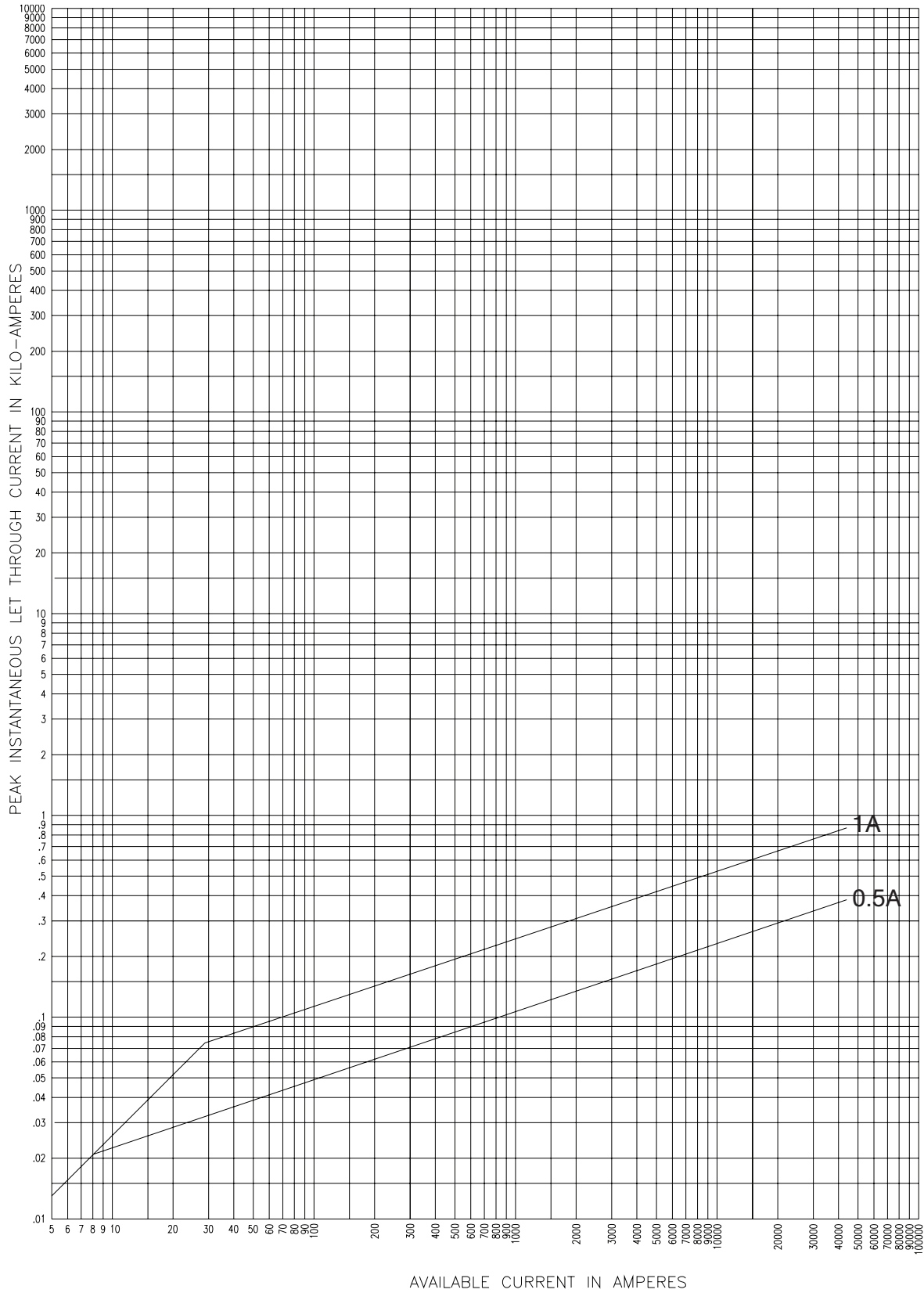

25CLPT\_

Curve TC63933901  
December 2008

**36 kV maximum system voltage**

Amp rating	Dimensions - in (mm)			Catalog No. (Interrupting rating - kA)		Recommended fuseclip
	Length A	Diameter B	Clip centers C	Indicating	Non-indicating	
2	17.3 (439)	1.6 (41)	16.1 (410)	—	36CAV2 (40)	1A0835
4				—	36CAV4 (40)	

**Dimensions (see catalog number tables for values)**

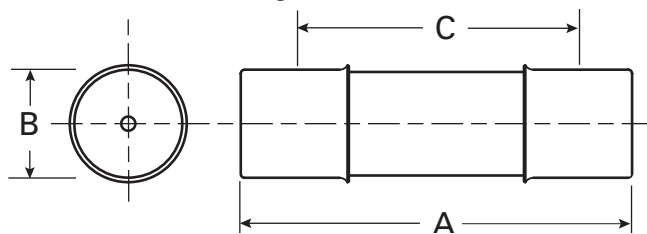

**Recommended fuseclips:**

Description	Cat. No.
Open fuseclip for 1.56 (39.7 mm) / 1.6 (40.6 mm) dia. fuses	1A0835

36 kV Time-current curves — minimum melting for 36CAV\_

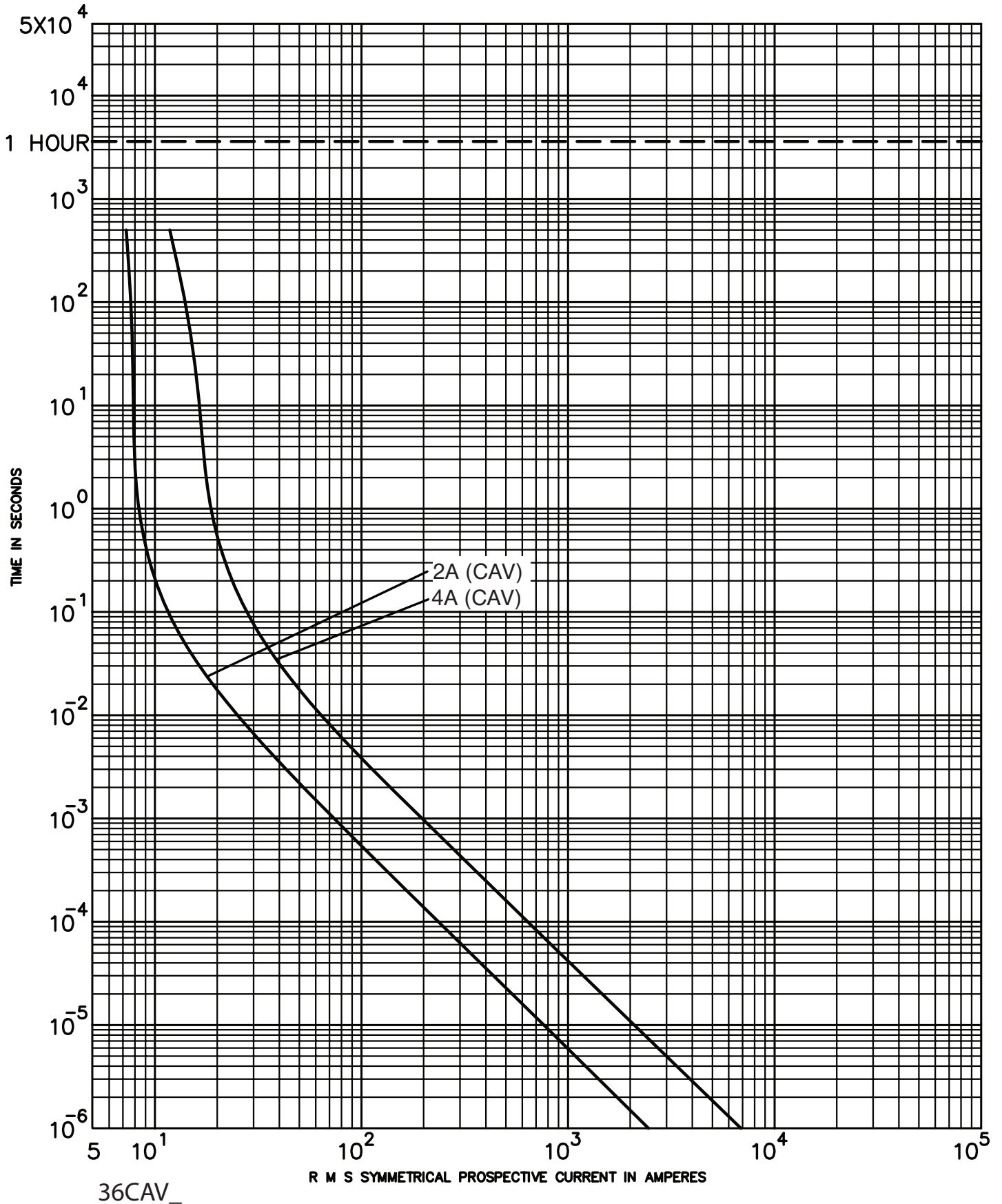

**38 kV maximum system voltage**

Amp rating	Dimensions - in (mm)			Catalog No. (interrupting rating - kA)		Recommended fuseclip
	Length A	Diameter B	Clip centers C	Indicating	Non-indicating	
0.5	17.3 (439)	1.6 (41)	16.1 (409)	38CAVH0.5E (40)	—	1A0835
0.5	18.6 (472)	1.6 (41)	17.1 (434)	38CLPT-0.5 (43.5) <sup>†</sup>	—	
1	17.3 (439)	1.6 (41)	16.1 (409)	38CAVH1E (40)	—	
2	17.3 (439)	1.6 (41)	16.1 (409)	38CAVH2E (40)	—	
4	17.3 (439)	1.6 (41)	16.1 (409)	—	38CAV4E (40)	

<sup>†</sup> Does not comply with ANSI C37.46 for “E” rating.

**CLPT Type Mountings and Hardware 38 kV Maximum (34.5 kV Nominal)**

Amp rating	Fuse mounting type	Catalog number			
		Mounting (including Live Parts, End Fittings)*		Live Parts (including end fittings)*	End fittings (disconnect only)
		Porcelain insulator	Glass-polyester insulator		
0.5	Disconnect <sup>†</sup>	Not applicable	Not applicable	CLPT-NL	CLPT-DF
	Non-disconnect	38CLPT-PNM-A	Not applicable	CLPT-DL	—

\* End fittings supplied only when required.

<sup>†</sup> Disconnect mountings provide a means for fuse extraction only. Do not use a disconnect mounting for load switching or fuse removal while energized.

**Dimensions (see catalog number tables for values)**

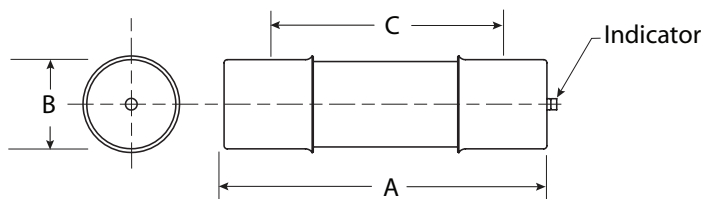

**Recommended fuseclip:**

Description	Cat. No.
Open fuseclip for 1.56 (39.7 mm) / 1.6 (40.6 mm) dia. fuses	1A0835

38 kV time-current curves — minimum melting for 38CAV\_ and 38CAVH

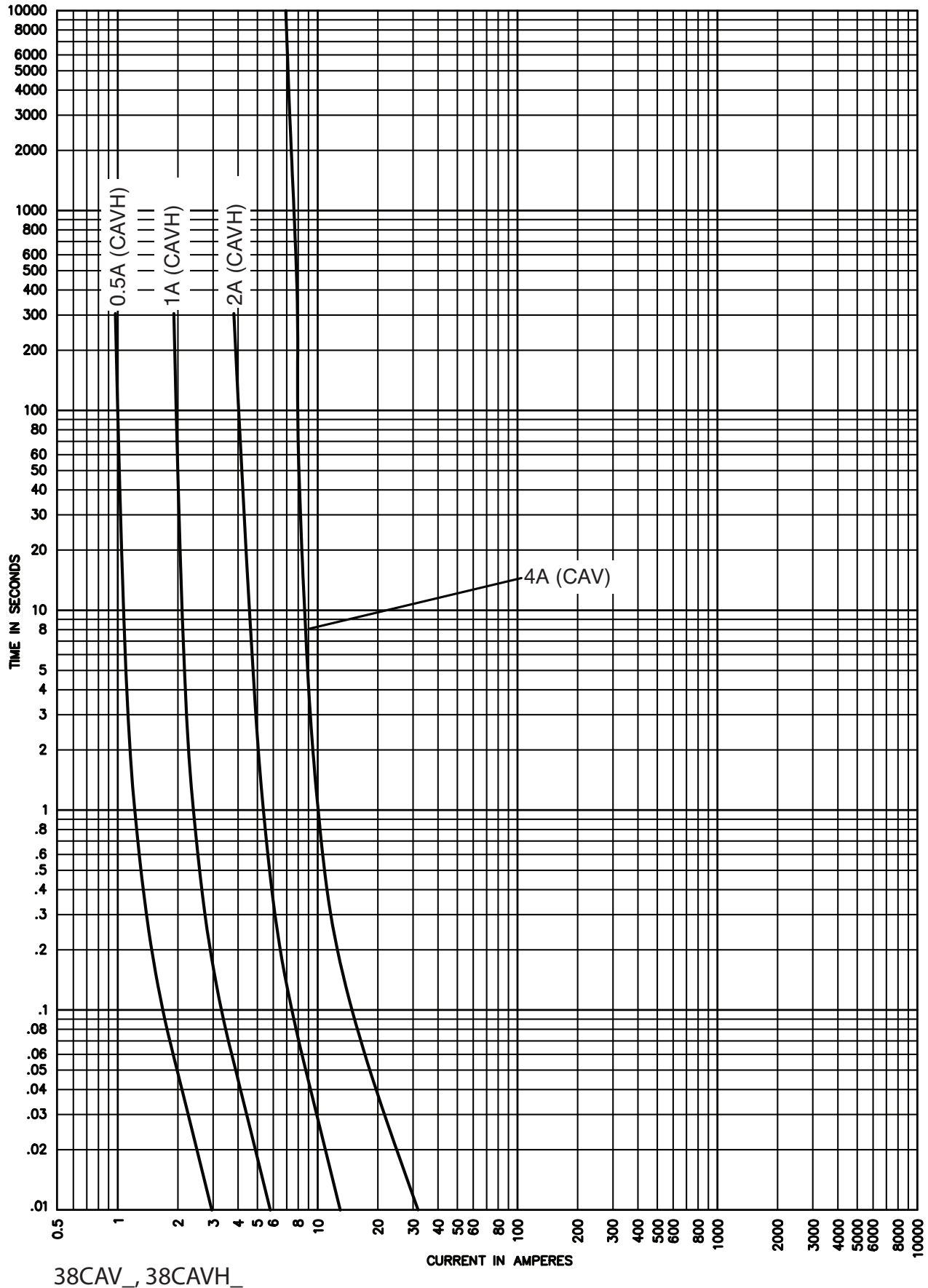

38CAV\_, 38CAVH\_



38 kV time-current curves — total clearing for 38CAV\_ and 38CAVH

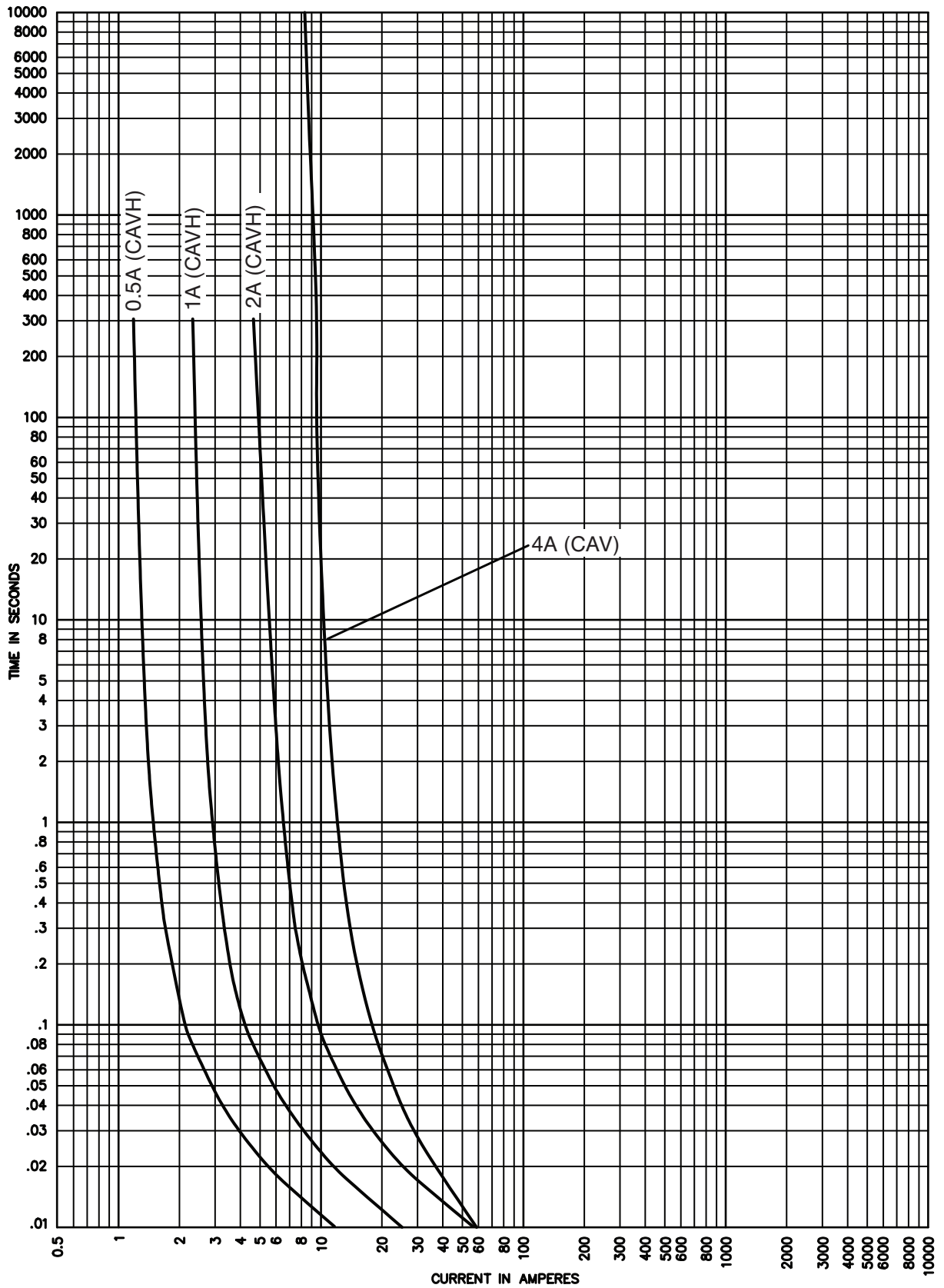

38CAV\_, 38CAVH\_

38 kV peak let-through curves for 38CAVH

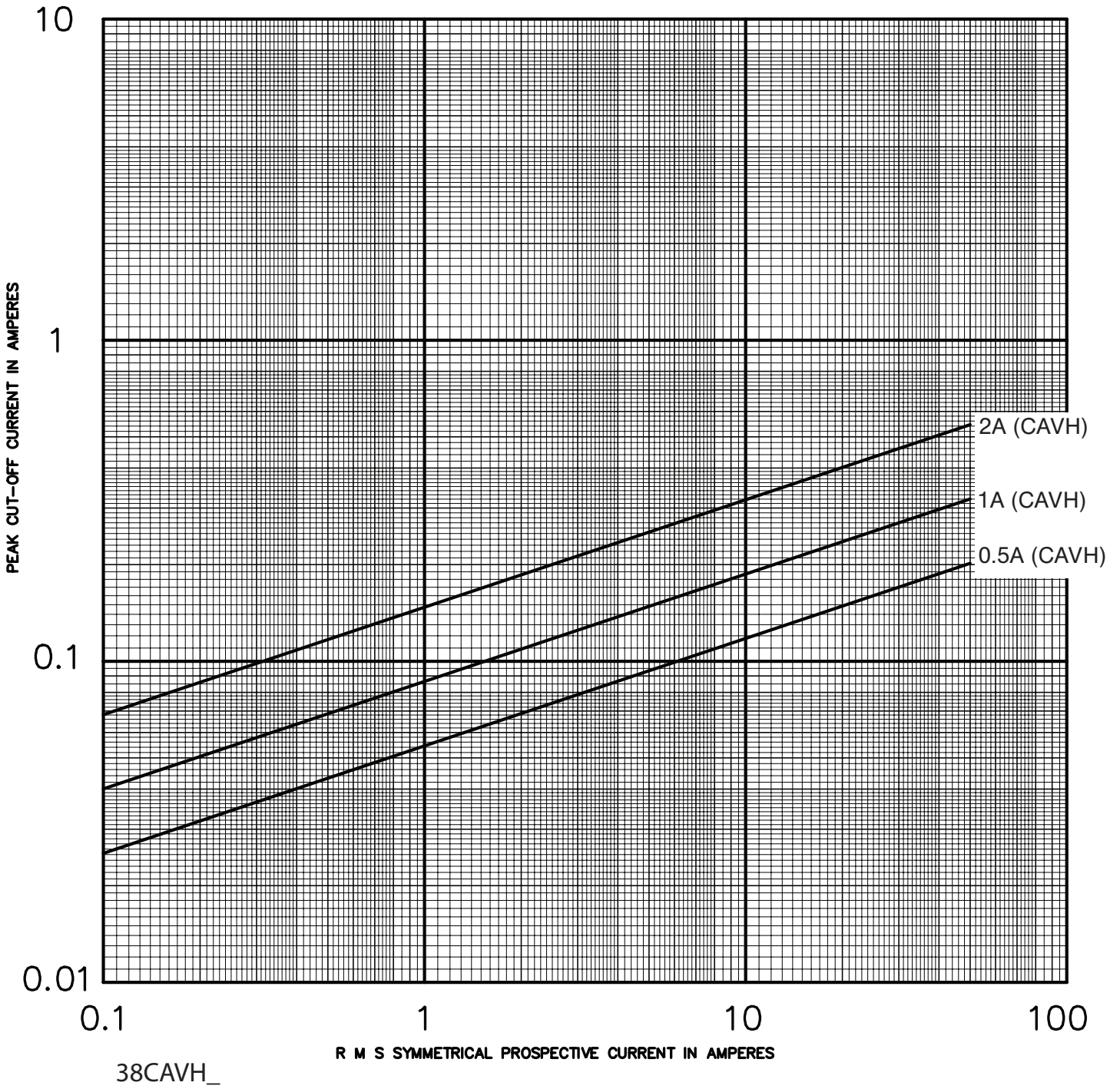

38 kV time-current curves – minimum melting for 38CLPT\_

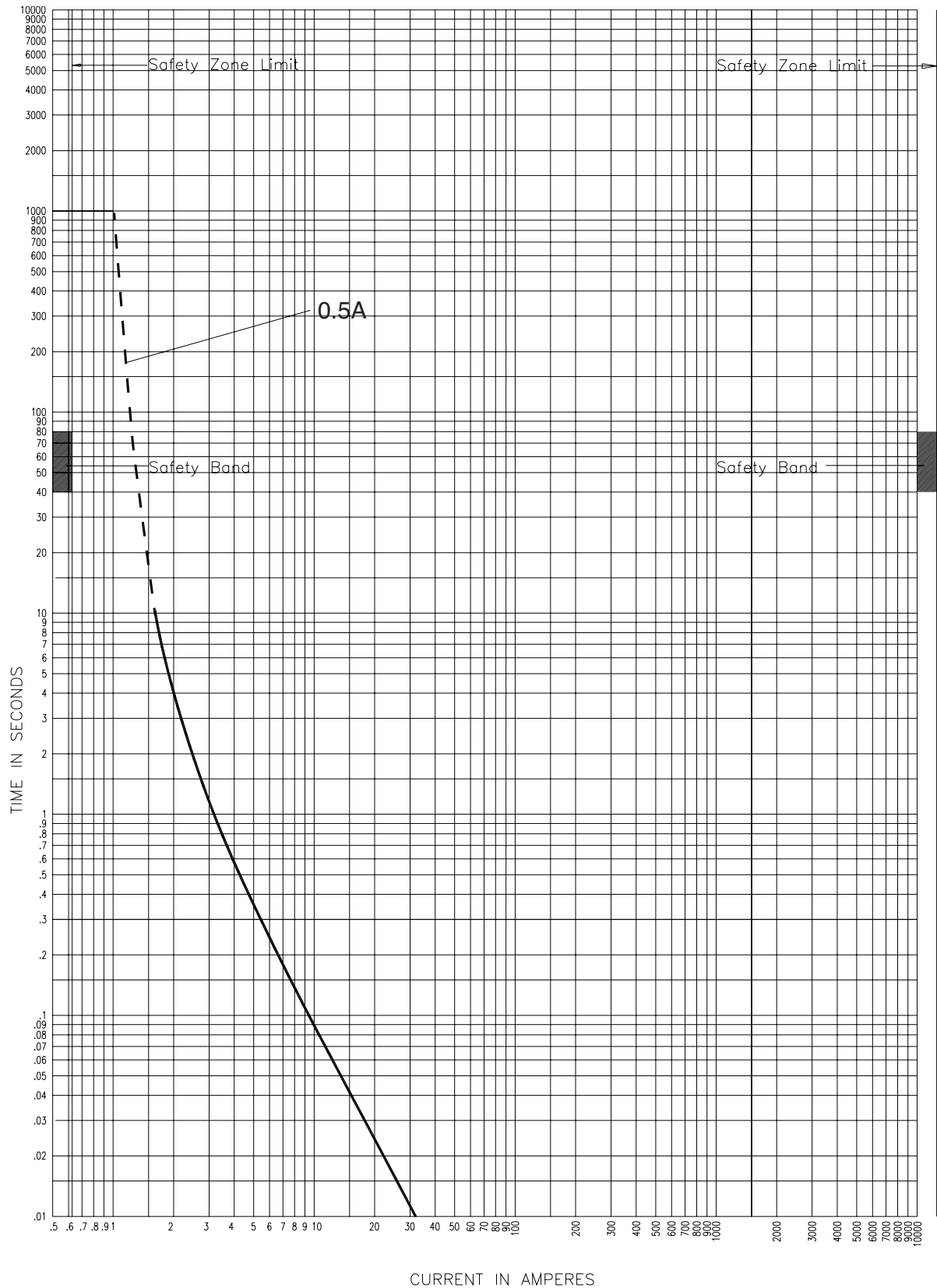

38CLPT\_

0.5 A fuse melt times in the dotted line region may not be assured due to manufacturing variations. The dotted lines show nominal operation. Some individual fuses may not open until current at 10-second mark is applied.

Curve TC56353208  
December 2008

38 kV time-current curves — total clearing for 38CLPT\_

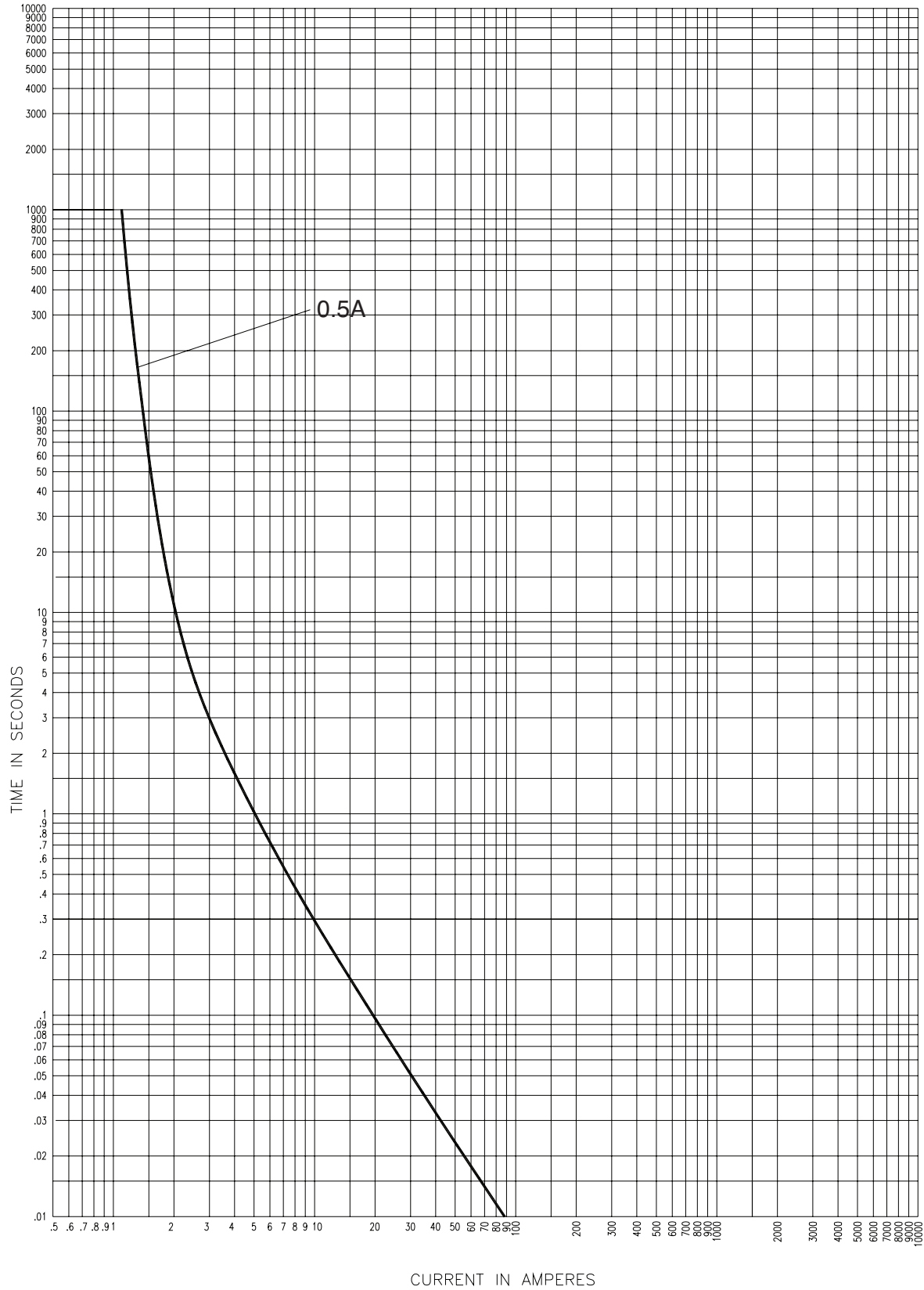

38CLPT\_

Curve TC56353308  
December 2008

38 kV peak let-through curves for 38CLPT\_

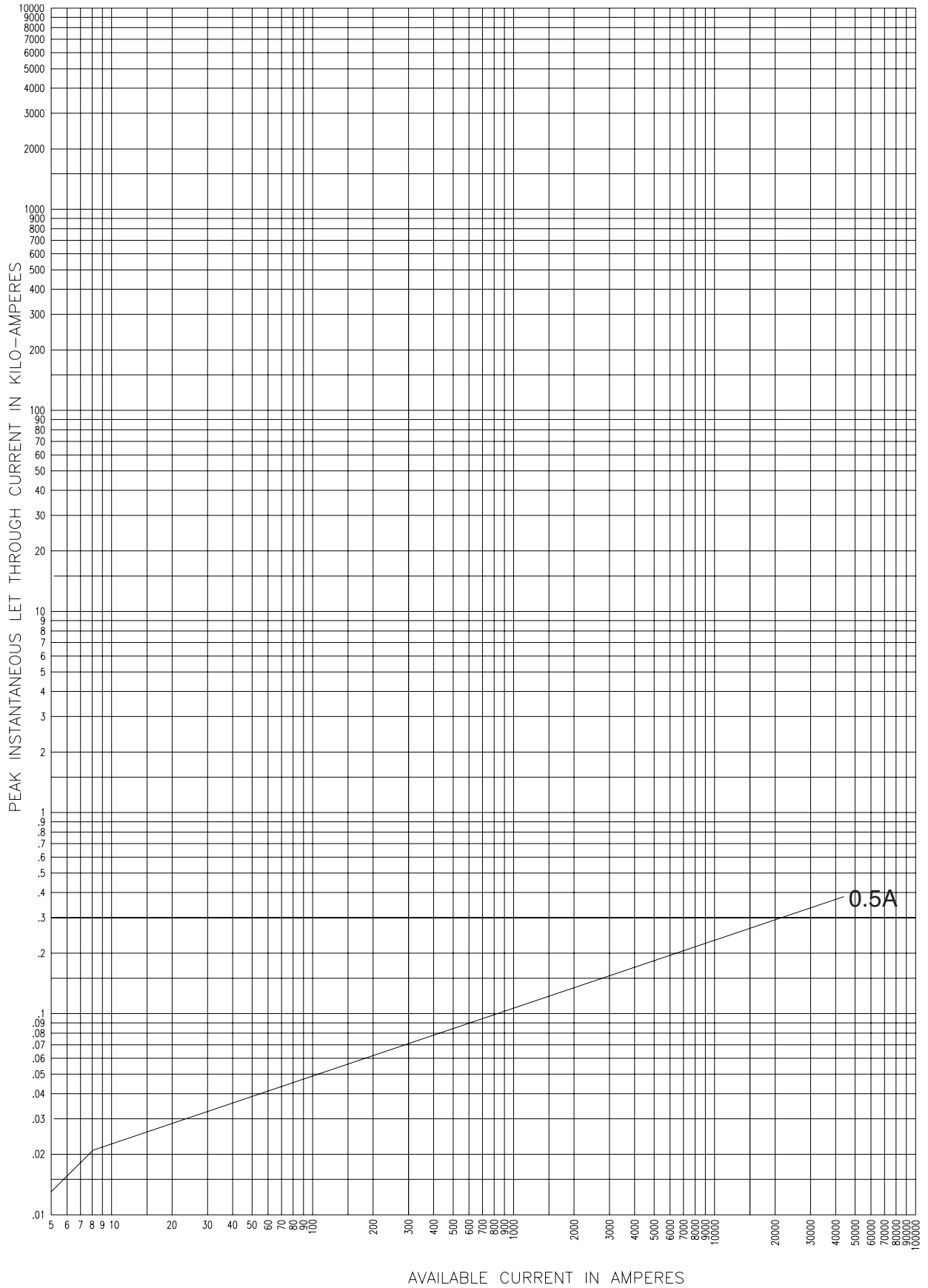

PT fuse mountings - in (mm)

Catalog number	Hole centers A	Hole centers B	Overall length C	Hole Inset D	Hole centers E	Contact height F	Overall height G	BIL kV
<b>5.5kV Disconnect†</b>								
5CLPT-GDM-A	9.37 (238)	6 (152.4)	18.63 (473.2)	0.75 (19)	1.75 (44.4)	4.5 (114.3)	9.56 (242.8)	60
5CLPT-PDM-A	9.37 (238)	6 (152.4)	18.63 (473.2)	0.75 (19)	1.75 (44.4)	4.5 (114.3)	9.56 (242.8)	60
<b>5.5kV Non-disconnect</b>								
5CLPT-GNM-A	9.37 (238)	6 (152.4)	18.63 (473.2)	0.75 (19)	1.75 (44.4)	4.5 (114.3)	6.94 (176.2)	60
5CLPT-PNM-A	9.37 (238)	6 (152.4)	18.63 (473.2)	0.75 (19)	1.75 (44.4)	4.5 (114.3)	6.94 (176.2)	60
<b>8.3kV Disconnect†</b>								
8CLPT-GDM-A	9.37 (238)	6 (152.4)	18.63 (473.2)	0.75 (19)	1.75 (44.4)	7 (177.8)	12.06 (306.3)	75
8CLPT-GDM-B	9.37 (238)	6 (152.4)	18.63 (473.2)	0.75 (19)	1.75 (44.4)	7 (177.8)	12.06 (306.3)	75
8CLPT-PDM-A	9.37 (238)	6 (152.4)	18.63 (473.2)	0.75 (19)	1.75 (44.4)	7 (177.8)	12.06 (306.3)	75
8CLPT-PDM-B	12.74 (323.6)	6 (152.4)	22 (558.8)	0.75 (19)	1.75 (44.4)	7 (177.8)	12.06 (306.3)	75
<b>8.3kV Non-disconnect</b>								
8CLPT-GNM-A	9.37 (238)	6 (152.4)	18.63 (473.2)	0.75 (19)	1.75 (44.4)	7 (177.8)	9.44 (239.8)	75
8CLPT-PNM-A	9.37 (238)	6 (152.4)	18.63 (473.2)	0.75 (19)	1.75 (44.4)	7 (177.8)	9.44 (239.8)	75
8CLPT-GNM-B	12.75 (323.8)	6 (152.4)	22 (558.8)	0.75 (19)	1.75 (44.4)	7 (177.8)	9.44 (239.8)	75
8CLPT-PNM-B	12.75 (323.8)	6 (152.4)	22 (558.8)	0.75 (19)	1.75 (44.4)	7 (177.8)	9.44 (239.8)	75
<b>15.5kV Disconnect†</b>								
15CLPT-GDM-A	12.74 (323.6)	6 (152.4)	22 (558.8)	0.75 (19)	1.75 (44.4)	7 (177.8)	12.06 (306.3)	95
15CLPT-PDM-A	12.74 (323.6)	6 (152.4)	22 (558.8)	0.75 (19)	1.75 (44.4)	7 (177.8)	12.06 (306.3)	95
15CLPT-GDM-B	17.46 (443.5)	6 (152.4)	26.63 (676.4)	0.75 (19)	1.75 (44.4)	7 (177.8)	12.06 (306.3)	95
15CLPT-PDM-B	17.46 (443.5)	6 (152.4)	26.63 (676.4)	0.75 (19)	1.75 (44.4)	7 (177.8)	12.06 (306.3)	95
<b>15.5kV Non-disconnect</b>								
15CLPT-GNM-A	12.74 (323.6)	6 (152.4)	22 (558.8)	0.75 (19)	1.75 (44.4)	7 (177.8)	9.44 (239.8)	95
15CLPT-PNM-A	12.74 (323.6)	6 (152.4)	22 (558.8)	0.75 (19)	1.75 (44.4)	7 (177.8)	9.44 (239.8)	95
15CLPT-GNM-B	17.46 (443.5)	6 (152.4)	26.63 (676.4)	0.75 (19)	1.75 (44.4)	7 (177.8)	9.44 (239.8)	95
15CLPT-PNM-B	17.46 (443.5)	6 (152.4)	26.63 (676.4)	0.75 (19)	1.75 (44.4)	7 (177.8)	9.44 (239.8)	95
<b>25.5kV Disconnect†</b>								
25CLPT-PDM-A	19.12 (485.6)	7 (177.8)	26.63 (676.4)	0.75 (19)	1.75 (44.4)	12 (304.8)	17.06 (433.3)	150
<b>25.5kV Non-disconnect</b>								
25CLPT-PNM-A	26.63 (676.4)	7 (177.8)	26.63 (676.4)	0.75 (19)	1.75 (44.4)	12 (304.8)	14.75 (374.6)	150
<b>38kV Non-disconnect</b>								
38CLPT-PNM-A	19.12 (485.6)	7 (177.8)	26.63 (676.4)	0.75 (19)	1.75 (44.4)	12 (304.8)	14.75 (374.6)	150

† Disconnect mountings provide a means for fuse extraction only. Do not use a disconnect mounting for load switching or fuse removal while energized.

**Disconnect mountings†**

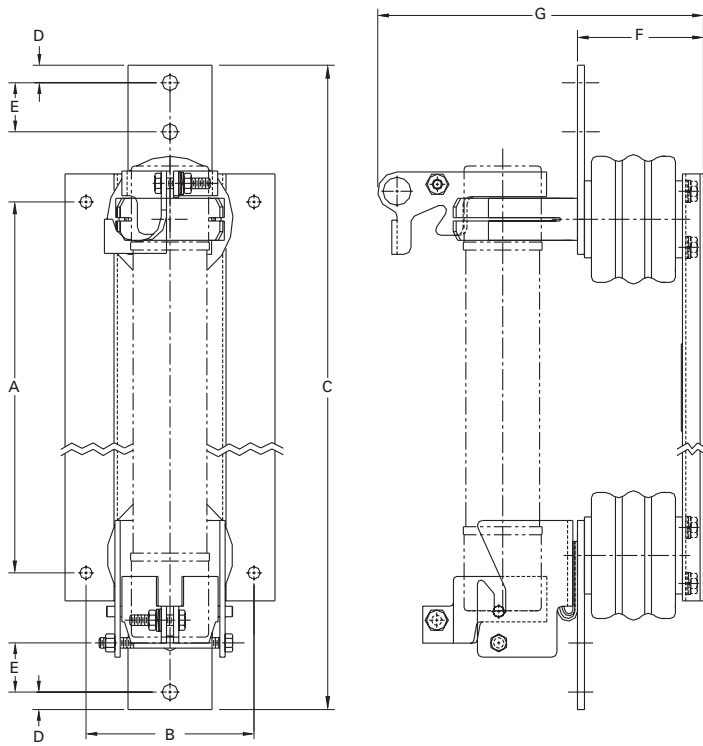

† Disconnect mountings provide a means for fuse extraction only. Do not use a disconnect mounting for load switching or fuse removal while energized.

**Non-disconnect mountings**

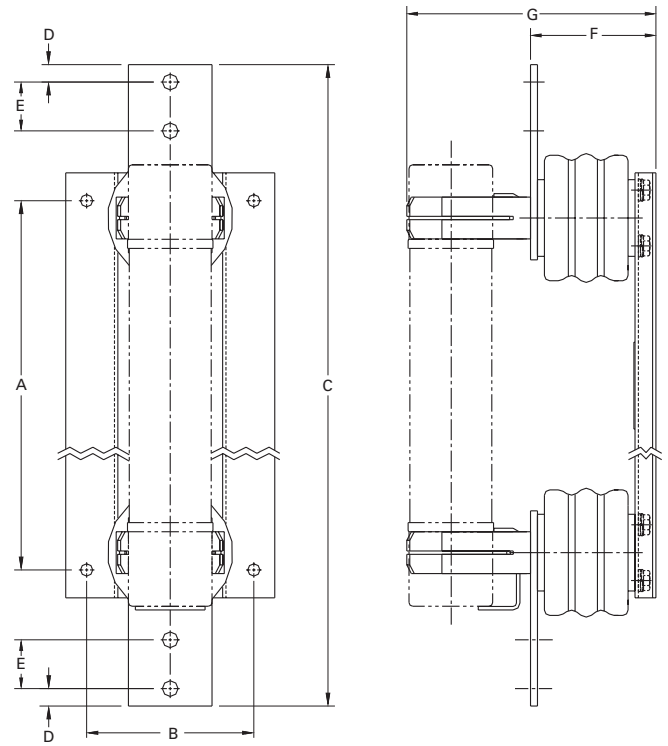

The only controlled copy of this data sheet is the electronic read-only version located on the Eaton network drive. All other copies of this document are by definition uncontrolled. This bulletin is intended to clearly present comprehensive product data and provide technical information that will help the end user with design applications. Eaton reserves the right, without notice, to change design or construction of any products and to discontinue or limit distribution of any products. Eaton also reserves the right to change or update, without notice, any technical information contained in this bulletin. Once a product has been selected, it should be tested by the user in all possible applications.

**Eaton**  
1000 Eaton Boulevard  
Cleveland, OH 44122  
United States  
Eaton.com

Bussmann Division  
114 Old State Road  
Ellisville, MO 63021  
United States  
Eaton.com/bussmannseries

© 2020 Eaton  
All Rights Reserved  
Publication No. 6002 – BU-SB15149  
September 2020

Eaton and Bussmann are valuable trademarks of Eaton in the US and other countries. You are not permitted to use the Eaton trademarks without prior written consent of Eaton.

For Eaton's Bussmann series product information, call **1-855-287-7626** or visit: **Eaton.com/bussmannseries**

Follow us on social media to get the latest product and support information.





# Mouser Electronics

Authorized Distributor

Click to View Pricing, Inventory, Delivery & Lifecycle Information:

[Eaton:](#)  
[24CAV2](#)